

GRIPPERS/SLIDES/ROTARIES

Table of Contents

Introduction:

Clean Room Solutions.....	GR-PRO-2
Modular Mounting Solutions/DirectConnect™	GR-PRO-3
North American Xpress Program	GR-PRO-8
European Xpress Program	GR-PRO-9
Product Sizing and Application Charts	GR-TCH-1



OEM Machine Builder.....GR-OEM



Electric Grippers GR-EPG



Precision Grippers GR-PRC



General Industrial Grippers .. GR-GEN



Heavy Duty GrippersGR-HDP



3-Jaw Parallel Grippers GR-3JP



Angular Grippers..... GR-ANG



Specialty Grippers GR-SPC



Rotary Actuators GR-ROT



Linear Slides..... GR-LIN

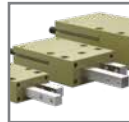

Feed Escapements..... GR-ESC



Robotic Tooling Solutions
(See TC-Automatic Tool Changers Catalog)

CLEAN ROOM RATED SOLUTIONS

Grippers/Slides/Rotaries | Product Overview

Destaco's Clean Room Rated Solutions are geared toward laboratory, semiconductor, medical, and food handling type environments. Many of our pneumatic products include a scavenge or purge port. These extra ports create internal vacuum or pressure to control contaminants escaping into the environment or prevent de-greaser or other chemicals penetrating our product.

Solutions include:

- Diverse line-up of products for class 10/100 cleanroom environments
- Manufactured with corrosion-resistant materials for use with de-ionized water
- Customized solutions available with food and medical grade lubricants, stainless steel, and nickel-plated materials to meet your application requirements.

Rating	Electric Parallel Grippers		
	RPE-100	DPE-200	DPE-400
ISO 4 (Class10)	☉☉		
ISO 5 (Class100)	☉		☉
ISO 6 (Class1,000)	☉	☉	☉
ISO 7 (Class10,000)	☉	☉	☉
ISO 8 (Class100,000)	☉	☉	☉

Rating	Pneumatic 2-Jaw and 3-Jaw Grippers									
	RPMC	RPLC	DPDS	DPDL	DPG	DPP	RDH	RTH	DCT	
ISO 4 (Class10)	☉☉	☉☉	☉☉							
ISO 5 (Class100)	☉☉	☉☉	☉☉	☉☉	☉		☉☉	☉☉		☉
ISO 6 (Class1,000)	☉☉	☉☉	☉	☉	☉		☉	☉		☉
ISO 7 (Class10,000)	☉	☉	☉	☉	☉	☉	☉	☉	☉	☉
ISO 8 (Class100,000)	☉	☉	☉	☉	☉	☉	☉	☉	☉	☉

Rating	Rotary Actuators		
	DRG	DRF	RR
ISO 4 (Class10)			
ISO 5 (Class100)	☉	☉	
ISO 6 (Class1,000)	☉	☉	
ISO 7 (Class10,000)	☉	☉	
ISO 8 (Class100,000)	☉	☉	☉

Rating	Linear Slides		
	DLB	DLT	DLM
ISO 4 (Class10)			
ISO 5 (Class100)			
ISO 6 (Class1,000)	☉	☉	☉
ISO 7 (Class10,000)	☉	☉	☉
ISO 8 (Class100,000)	☉	☉	☉

- ☉ Standard Clean Room
- ☉☉ With use of Scavenge Port

Note: All products tested using Krytox™ Grease. Please contact factory for individual test results and additional clean room requirements.

MODULAR MOUNTING SOLUTIONS

Grippers/Slides/Rotaries | Product Overview

Destaco's modular automation systems feature DIRECTCONNECT™ technology, allowing all components of the system—base slides, block thrusters, thruster slides, grippers, and mounting stanchions—to be mounted together quickly and easily without any adapter plates.

- Reduces engineering design
- Saves \$\$\$ with modular solutions
- Change device orientations quickly
- Eliminates Adapter Plates

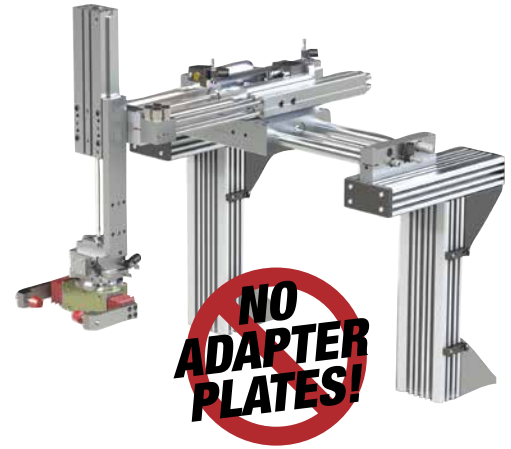

Modular DIRECTCONNECT Mounting Style Examples:

Look for more examples of each main section of the catalog. This is a sample of configurations we offer. Custom solutions also available.

Grip & Rotate

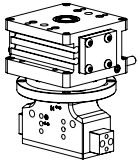

DRF Rotary Actuator to DPDL Parallel Gripper

Pick & Rotate

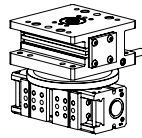

DRF Rotary Actuator to DPP Parallel Gripper

Place & Rotate

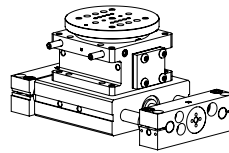

DLB Base Slide to DRF Rotary Actuator

Place & Rotate

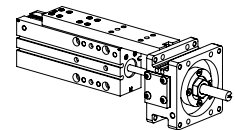

DLM Linear Slide to DRG Rotary Actuator

Rotate & Place

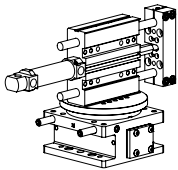

DRF Rotary Actuator to DLT Linear Slide

Pick & Place

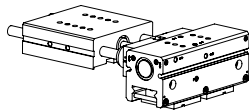

DLT Base Slide to DPP Parallel Gripper

Place & Place

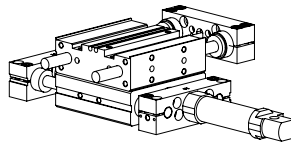

DLB Base Slide to DLT Linear Slide

Place & Place

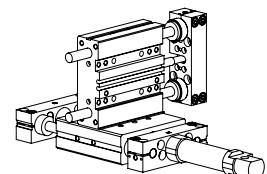

DLB Base Slide to DLT Linear Slide

Connect Different Sizes & Styles

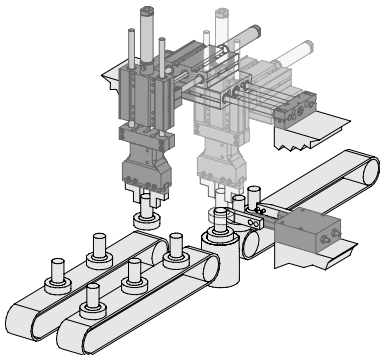

Configure in Multiple Orientations

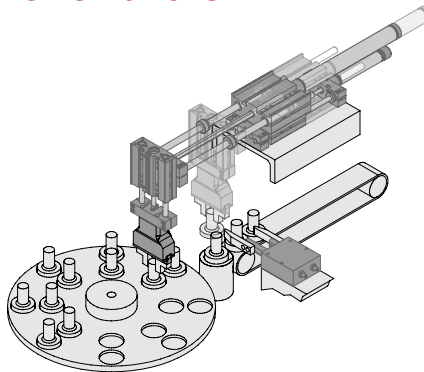

Look for the DIRECTCONNECT Logo

Product Series beginning with the letter D have a DIRECTCONNECT option, with a few exceptions.

DIRECTCONNECT™

HOW TO MAKE A DIRECTCONNECT™ MOUNT

Grippers/Slides/Rotaries | Product Overview

The DIRECTCONNECT Modular Compatibility Chart (on the next page) shows all the products that can easily connect together without adapter plates. Simply locate your first product along the horizontal axis of the top of chart, then locate the second product along the vertical axis on the left side of the chart. If a connection can be made, a mounting pattern will be shown.

DIRECTCONNECT Modular Compatibility Example:

Shown below, a DLB-10,12,16 Base Slide connecting to a DLT-10,12,16 Linear Thruster. Units may connect on different faces of the unit. Please refer to individual datasheets for DIRECTCONNECT mounting surfaces.

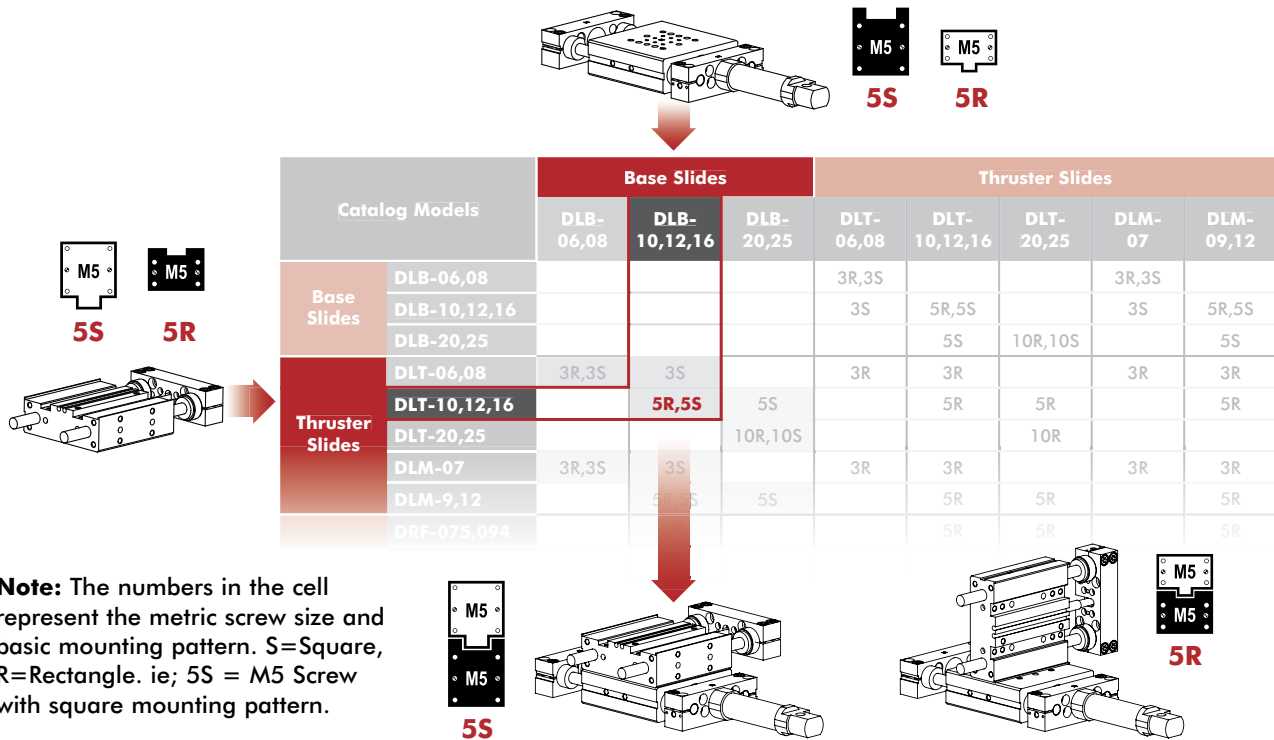

DirectConnect Mounting Surface Example:

Locate matching DIRECTCONNECT mounting pattern icons on the products dimensional drawings to determine what surface faces can be connected to. Corresponding mates equal a DIRECTCONNECT connection.

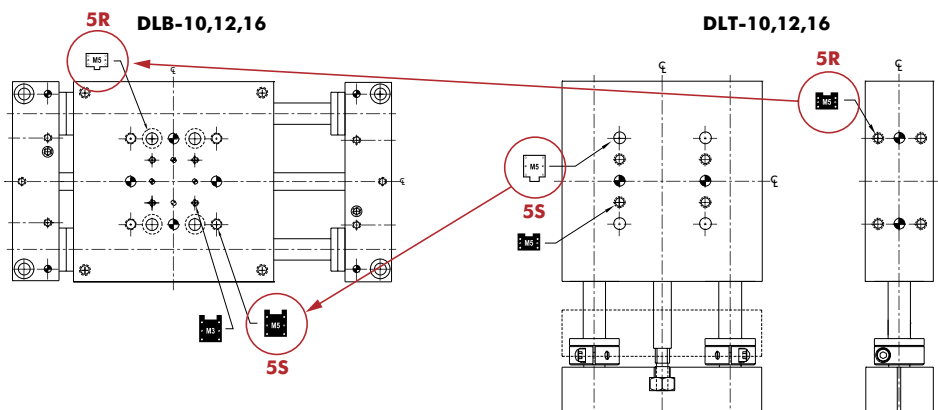

DIRECTCONNECT™ MODULAR COMPATIBILITY CHART

Grippers/Slides/Rotaries | Product Overview

Destaco's modular automation systems feature DirectConnect™ technology, allowing all components of the system—base slides, block thrusters, thruster slides, grippers, and rotaries—to be mounted together quickly & easily without any adapter plates. Look for matching icons on product datasheets for mounting compatibility.

Simply locate your first product along the horizontal axis of the top of chart, then locate the second product along the vertical axis on the left side of the chart. If a connection can be made, a mounting pattern will be shown.

Note: The numbers in the cell represent the metric screw size and basic mounting pattern. S=Square, R=Rectangle. ie; 5S = M5 Screw with square mounting pattern.

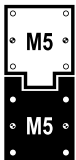

M5 (S)quare

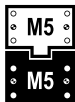

M5 (R)ectangle

Catalog Models		Base Slides		
		DLB-06&08	DLB-10,12&16	DLB-20&25
Base Slides	DLB-06 & 08			
	DLB-10, 12 & 16			
	DLB-20 & 25			
Thruster Slides	DLT-06 & 08	3R,3S	3S	
	DLT-10, 12 & 16		5R,5S	5S
	DLT-20 & 25			10R,10S
	DLM-07	3R,3S	3S	
	DLM-9 & 12		5R,5S	5S
Rotary Actuators	DRF-075 & 094		5R	
	DRF-106		5R	10R
	DRF-131		5R	10R
	DRG-074 & 094		5R	
	DRG-106		5R	10R
	DRG-131		5R	10R
Grippers	DGC		5R	
	DPG		5R	
	DCT-12, 16 & 25	3R		
	DCT-25		5R	
	DPDL-047 & 056	3R		
	DPDL-088 & 125		5R	
	DPDL-175 & 250			10R
	DPDS-047 & 056	3R		
	DPDS-088 & 125		5R	
	DPDS-175 & 250			10R
	DPL-25xx		5R	
	DPL-32xx & 40xx			10R
	DPP-10 & 14	3R		
	DPP-20		5R	
	DPP-28		5R	10R
	DPW-250	3R		
	DPW-375 & 500		5R	
	G110-08 & 011	3R		
	G110-18 & 25		5R	
	DPE-200		5R	
DPE-400			10R	

DIRECTCONNECT™ MODULAR COMPATIBILITY CHART

Grippers/Slides/Rotaries | Product Overview

Thruster Slides					Rotary Actuators		
DLT-06&08	DLT-10,12&16	DLT-20&25	DLM-07	DLM-09&12	DRF-075&094	DRF-106	DRF-131
3R,3S			3R,3S				
3S	5R,5S		3S	5R,5S	5R	5R	5R
	5S	10R,10S		5S		10R	10R
3R	3R		3R	3R	3R,3S	3R,3S	
	5R	5R		5R	5R,5S	5R,5S	5R,5S
		10R					10R,10S
3R	3R		3R	3R	3R,3S	3R,3S	
	5R	5R		5R	5R,5S	5R,5S	5R,5S
	5R	5R		5R	5R	5R	5R
	5R	10R		5R	5R	5R	10R
	5R	10R		5R	5R	5R	10R
	5R	5R		5R	5R	5R	5R
	5R	10R		5R	5R	5R	10R
	5R	10R		5R	5R	5R	10R
	5R	5R		5R	5R	5R	5R
	5R	5R		5R	5R	5R	5R
3R	3R		3R	3R	3R	3R	
	5R	5R		5R	5R	5R	5R
3R	3R		3R	3R	3R	3R	
	5R	5R		5R	5R	5R	5R
		10R					10R
3R	3R		3R	3R	3R	3R	
	5R	5R		5R	5R	5R	5R
		10R					10R
	5R	5R		5R	5R	5R	5R
		10R					10R
3R	3R		3R	3R	3R	3R	
	5R	5R		5R	5R	5R	5R
	5R	10R		5R	5R	5R	10R
3R	3R		3R	3R	3R	3R	
	5R	5R		5R	5R	5R	5R
3R	3R		3R	3R	3R	3R	
	5R	5R		5R	5R	5R	5R
	5R	5R		5R	5R	5R	5R
		10R					10R

NOTES

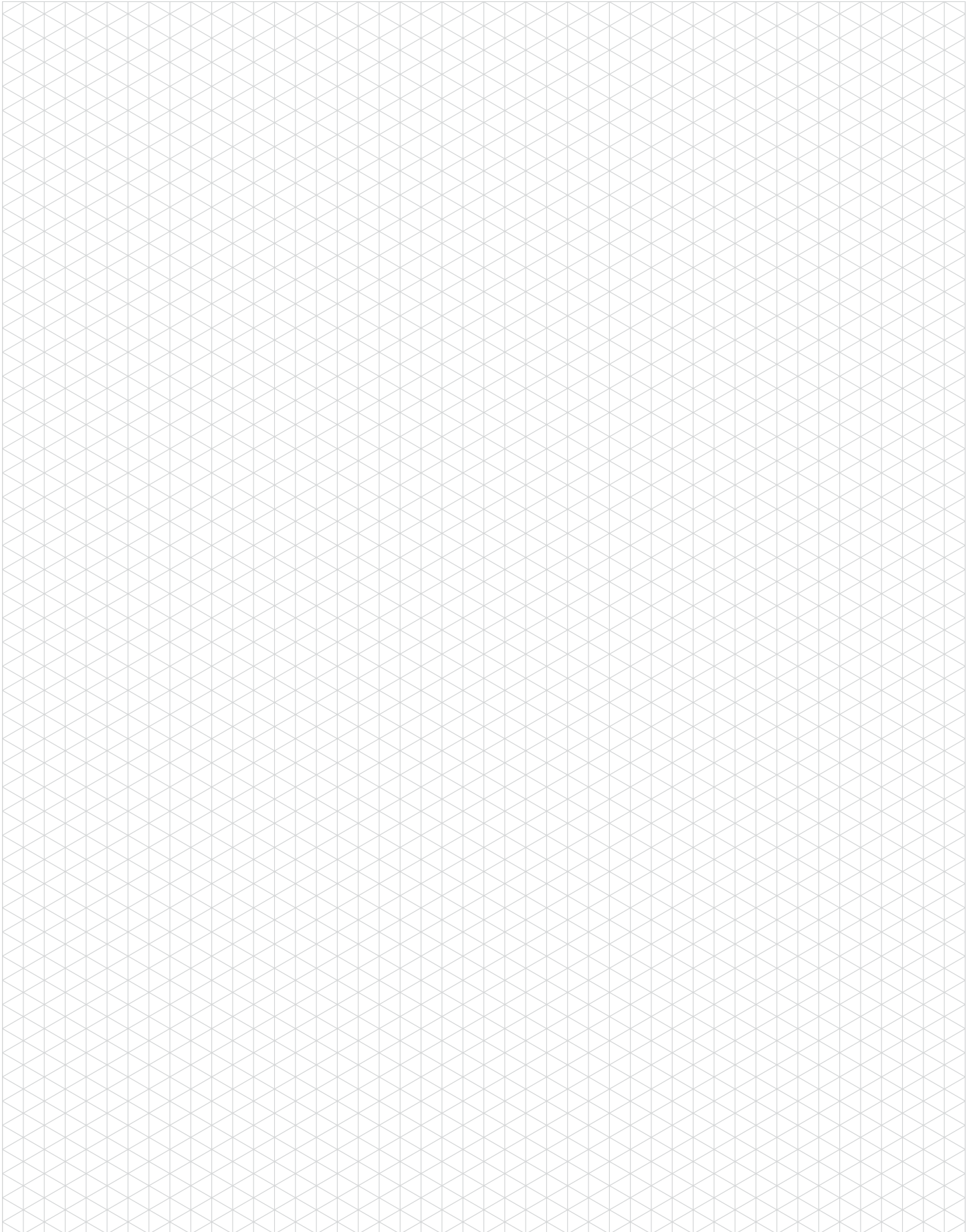

NORTH AMERICAN XPRESS PROGRAM









A Full Line of Automation Products to Meet Your Application Needs Quickly



STANDARD LEAD TIME

Product listed below are for North American Market only.

Parallel Grippers

		 SIZE	 STROKE [mm]	 FORCE [N]
	RP Series Rugged Impact Resistant Gripper	5, 10, 11, 12, 15	4.0-12.7	156-311
	RPL/RPLC Series Zero Side Play, High Repeatability Gripper	1, 2, 3, 4 (C)=Clean Room Version	6.4-25.4	116-160
	RPM/RPMC Series Low Friction Micro Gripper	1, 2, 3, (C)=Clean Room Version	4.1-6.3	36
	DPG Series Modular Multi-Part Sensing Gripper	10M-2	12.7	222
	HEAVY DUTY DPW Series Wide Parts/ Long Finger Gripper	250, 375, 500	19.05-63.5	222-800
	HEAVY DUTY RPW Series Wide Parts/ Long Finger Gripper	625	50.8-88.9	1068

Angular Grippers

		 SIZE	 ANGLE	 FORCE [N]
	RA Series Low Cost Small Size Angular Gripper	RA-5	15° (per finger)	89

Rotary Actuators

		 SIZE	 ANGLE	 PAYLOAD [Kg]
	RR Series High Torque Compact Rotary Actuators	18, 28, 36	0-180°	0.45-3.6

To choose the best and most cost-effective automation solution for your application please contact your Destaco sales representative or Destaco customer service.

EUROPEAN XPRESS PROGRAM

A Full Line of Automation Products to Meet Your Application Needs Quickly



STANDARD LEAD TIME

Product listed below are for European Market only.



SIZE











STROKE [mm]



FORCE [N]

Parallel Grippers

		SIZE	STROKE [mm]	FORCE [N]
	RTH Series 3 Jaw Centering Gripper	1, 2, 3, 4, 5, 6	4-70	445-44353
	RP Series Rugged Impact Resistant Gripper	5, 10, 11, 12, 15	4.0-12.7	156-311
	RPL/RPLC Series Zero Side Play, High Repeatability Gripper	RPL: 1, 2, 3, 4 RPLC: 1, 3 (C)=Clean Room	6.4-25.4	116-160
	RPM Series Low Friction Micro Gripper	1, 3	4.1-6.3	36
	DGC Series Precision Spring Gripper	25, 45, 65	20-40	432-11475
	RDH Series Shielded Gripper	1, 2, 3, 4, 5, 6 with Options -C, -L	4-70	361-28002
	DPW Series Wide Parts/ Long Finger Gripper	250, 375, 500	19.05-63.5	222-800
	RPW Series Wide Parts/ Long Finger Gripper	625, 750	19.1-114.3	222-2091

To choose the best and most cost-effective automation solution for your application please contact your Destaco sales representative or Destaco customer service.

EUROPEAN XPRESS PROGRAM

A Full Line of Automation Products to Meet Your Application Needs Quickly



STANDARD LEAD TIME

Product listed below are for European Market only.

Rotary Actuators



SIZE



ANGLE

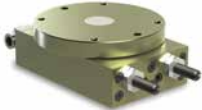

PAYLOAD [Kg]

	RR Series High Torque Compact Rotary Actuators	18, 28	0-180°	0.45-1.3
	HEAVY DUTY RR Series High Torque Compact Rotary Actuators	36, 45, 56, 66	0-180°	3.6-91

Tool Changers





SIZE



PORTS



PAYLOAD [Kg]

	HEAVY DUTY RQC Series Robot Side	200, 400, 800, 1200 Options E19, G19	19 pin Electrical and 6 Pneumatic Ports	90-550
	HEAVY DUTY RTP Series Tool Side			
	QC Series Robot Side	30, 60, 150 Options E12, E15	12-15 pin Electrical and 4 Pneumatic Ports	30-150
	TP Series Tool Side			

To choose the best and most cost-effective automation solution for your application please contact your Destaco sales representative or Destaco customer service.