

84N Series

Sheet Metal Press Room Gripper Products

DESTACO Introduces the newest addition to its line of stamping press sheet metal gripping solutions.

The Accelerate® sheet metal press room gripper is half the weight and more compact, with faster actuation — when compared to our closest competition⁽¹⁾ — without sacrificing grip force which measures up to 1000 N at 5 bar.

The lighter, smaller and faster 84N series gripper accelerates stamping press operations by helping customers produce more stamped parts per hour with higher efficiency while reducing moment forces and overall system wear and tear.



Product Highlights/Options

- Standard, chisel and 90° jaw options
- 30°, 45°, 60° and 75° jaw opening available
- Flexible mounting options
- Part present sensing
- One-step tip adjustment tool





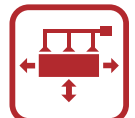







GRIPPING



PICK AND PLACE

Features, Markets and Applications

 <p>COMPACT SIZE</p>	<ul style="list-style-type: none"> • 12% smaller footprint ^(*) • Zero protrusion fixed jaw • No protrusion of top jaw mechanism below body 	 <p>AUTOMOTIVE</p>	 <p>STAMPING</p>
 <p>LIGHTWEIGHT</p>	<ul style="list-style-type: none"> • 60% lighter, weighing only 0.27kg (vs 0.56kg) ^(*) • Body constructed of lightweight aluminum 	 <p>CONSUMER</p>	 <p>ASSEMBLY</p>
 <p>PERFORMANCE</p>	<ul style="list-style-type: none"> • 60% faster actuation time at 33ms (vs 50ms) ^(*) • Compact and powerful, with a grip force up to 1000N at 5 bar • Integrated clamp-loss protection 	 <p>AEROSPACE</p>	 <p>CNC MACHINING</p>
		 <p>PACKAGING</p>	 <p>FIXTURE/TEST</p>

ACCELERATE® PRESS ROOM GRIPPER

84N1 Series Sheet Metal Gripper with Adjustable Tips

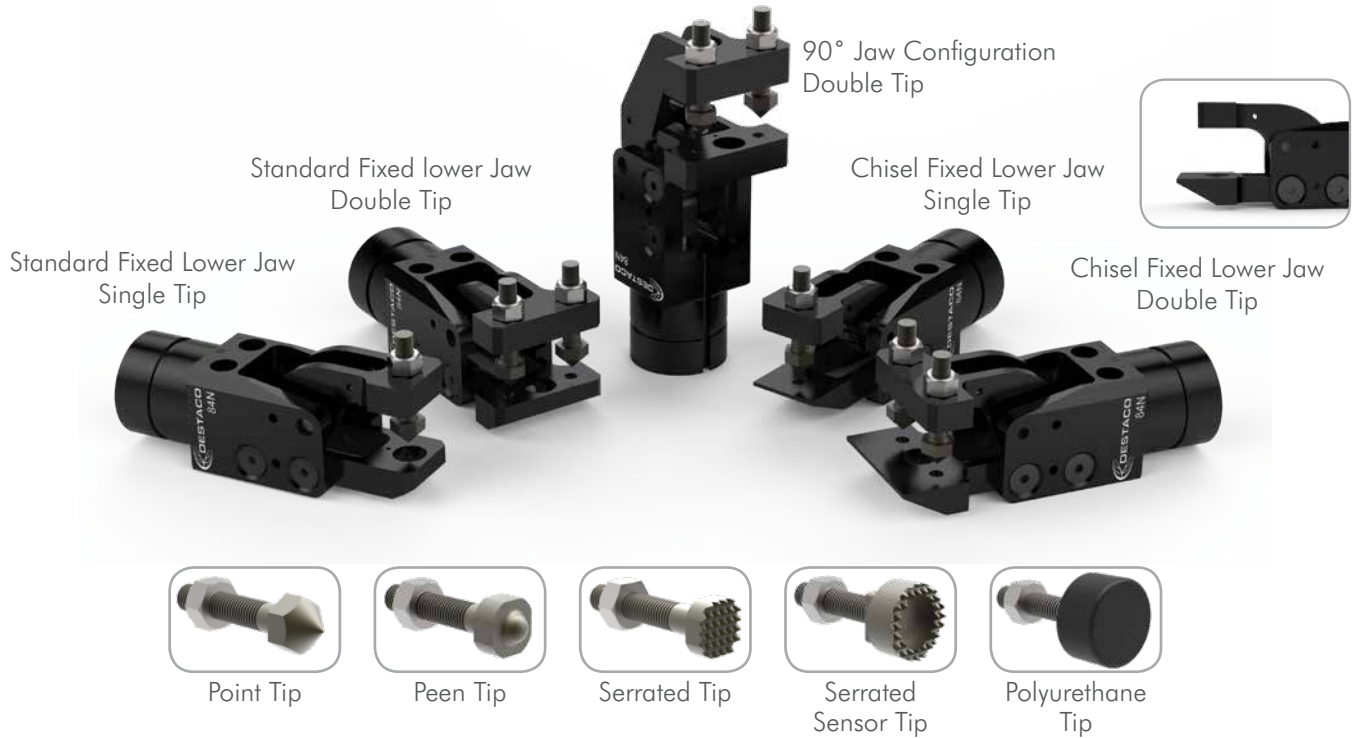

84N2 Series Sheet Metal Gripper with Fixed Tips



ACCELERATE® PRESS ROOM GRIPPER

84N Series Mounting and Sensor Options



Rear Flange
Gripper Mount



32mm or 1.125 inch
Rear Ball Gripper Mount



25mm Tube
1.00/1.25 inch Tube
or 30mm Bodybuilder
Parallel Swivel
Gripper Mount



32mm or 1.125 inch
Side Ball Gripper Mount

19mm or 20mm
Apple Core Gripper Mount



Clamp-Loss Prevention
Feature



Double Blank Detector
Sensor Kit



Part Present Detector
Sensor Kit



Sheet Stop

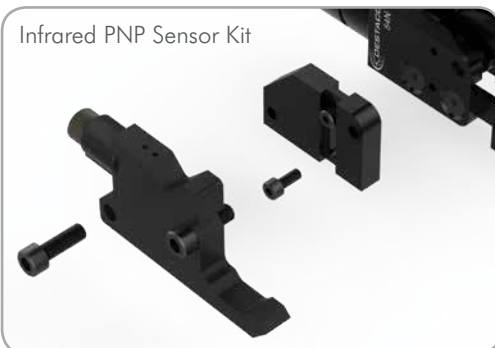

Infrared PNP Sensor Kit



84N2 with Rear Flange Mount and
Double Blank Detector Sensor Kit



84N1 with 32mm Side Ball Mount
and Infrared PNP Sensor Kit

84N Series Sheet Metal Gripper used with Accelerate Lightweight Tooling.

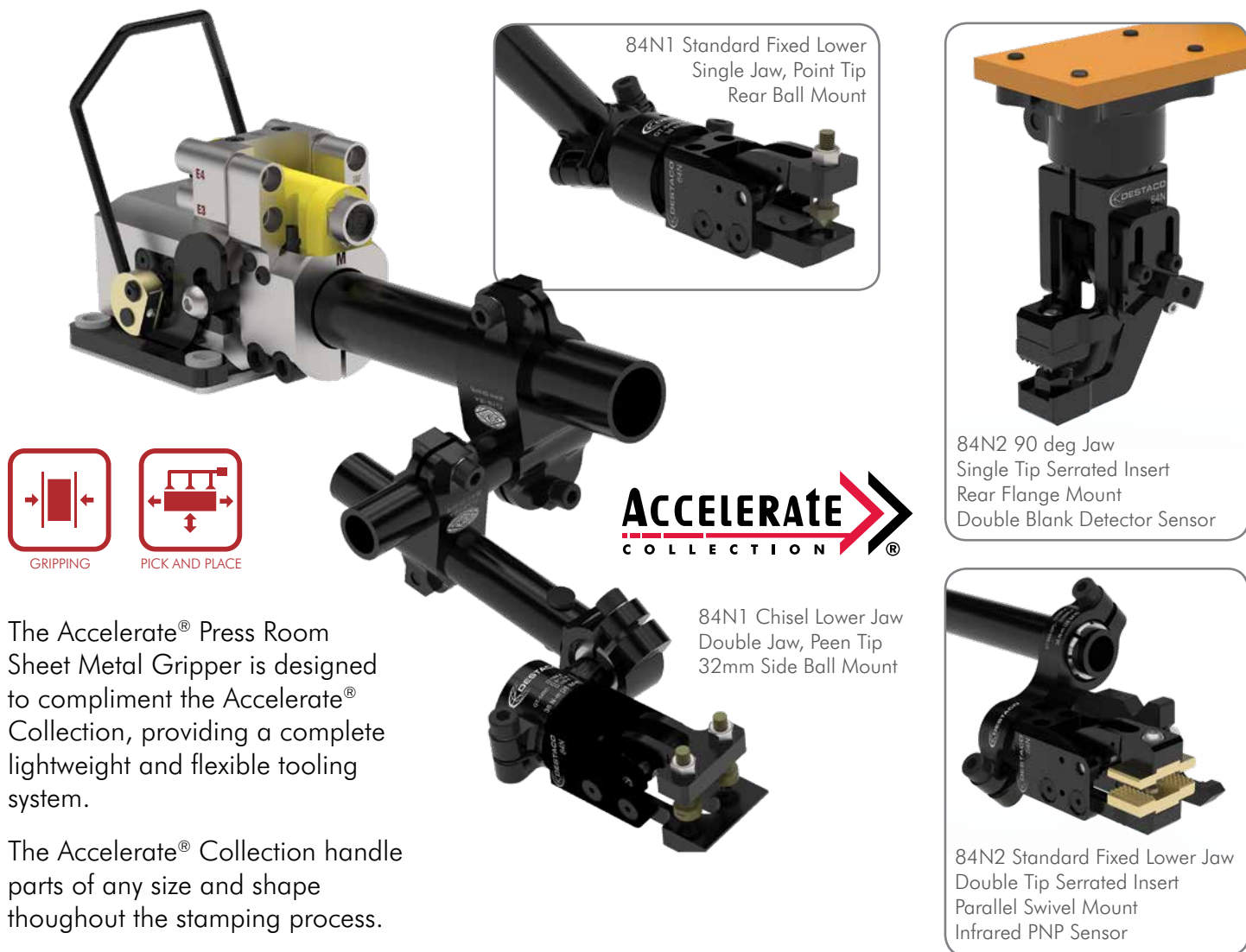

The Accelerate® Press Room Sheet Metal Gripper is designed to compliment the Accelerate® Collection, providing a complete lightweight and flexible tooling system.

The Accelerate® Collection handle parts of any size and shape throughout the stamping process.

The Accelerate® Press Room Sheet Metal Gripper is:

60% lighter* (0.27kg vs 0.56kg)

12% smaller* foot print

60% faster* actuation (33ms vs 50ms)

100% DESTACO innovation

*When compared with our closest Competition

Specification	Unit	
Grip Force at 5 bar	N	Up to 1000
Weight (FC00 version)	Kg	.27
Size L x W x H (closed)	mm	110 x 43 x 43
Size L x W x H (open)	mm	110 x 43 x 64
Actuation Time	ms	33
Life	cycles	5 million
Minimum Operating Pressure	bar	1
Opening Angles		30°, 45°, 60°, 75°
Piston Ø	mm	25
Air Consumption/Cycle	L	.015

Dimensions and technical information are subject to change without notice.

GERMANY
+49-6171-705-0
europe@destaco.com

UNITED KINGDOM
+44-1902-797980
uk@destaco.com

NETHERLANDS
+31-297285332
benelux@destaco.com

THAILAND
+66-2-326-0812
asia@destaco.com

USA
+1-888-DESTACO
+1-248-836-6700
northamerica@destaco.com

FRANCE
Tel: +33-4-7354-5001
france@destaco.com

SPAIN
+34-936361680
spain@destaco.com

CHINA
+86-21-6081-2888
china@destaco.com

INDIA
+91-80-41123421-426
india@destaco.com