

PNEUMATIC POWER CYLINDERS

Features

Your requirements

Power element of machines, tools and devices for the following applications:

- Clamping
- Coining
- Punching
- Riveting
- Stamping
- Pressing
- Notching
- Clinching

The solution

DESTACO's double acting power cylinder, which is based on the wedge lever principle.

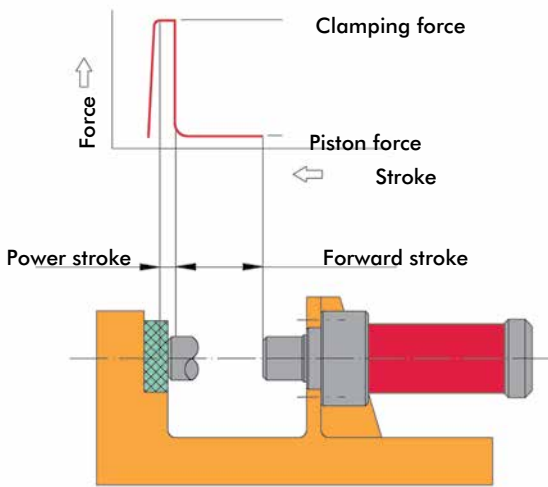

Product features

- Mechanical advantage: 10:1
- Characteristic are the two steps of stroke: the forward stroke to move a certain distance and the power stroke with an amplified force on a short distance
- Exact positioning of cylinder by flange mount on cylinder's head
- Cylinder works in any position
- High durability because of solid and maintenance free wedge lever mechanics.
- End position control by magnetic field sensing

Technical Data	
Power forces at 6 bar	4 – 60 kN
Forward strokes	15 – 200 mm
Power strokes	6 and 7 mm*
Air pressure	max. 6 bar, min 3 bar
Mechanical advantage	max. 10:1
Cylinders require clean, water- and oil free air	

*power strokes up to max. 12 mm upon request

Round design: Type K and WK

- Piston rod with male thread (Type K) or ISO fit (Type WK)



Rectangular design: Type WR

- Two piston rods prevent twisting



Application Recommendations

- Compressed air should be treated by filter, water separator and pressure regulator. Oiler is not allowed!
- For an adequate piston speed air hoses with 6mm I.D. should be used.
- Do not increase the max. air pressure of 6 bar, because this would reduce the cylinder's life cycle considerably.
- The piston rods of type K and WK are not secured against twisting, an external device should be provided.
- Piston rod should not be subjected to transversal forces. Force should always be exerted by coaxial force through the piston rod to the work piece.
- For Type WR, force must be transmitted via the centre of the pressure plate.
- Connection between rod and tool should be performed as frictional connection (coupling), not as form fitting connection.
- For punching operations we recommend a force reserve of approx. 30 %.
- If the cylinder is used for positioning in the extended rod position you should consider that a possible counter-force will cause an axial deflection of approx. 1 mm. This feature is due to the cylinder's design because after the nominal power stroke the clamping force drops down to the level of the piston force (see force-stroke diagram left side).
- Valves are not usable to avoid piston movement. If the piston should be positioned within the range of the forward stroke, both chambers of the cylinder have to be vented. If the cylinder should stay at a retracted position the piston rod chamber should be under pressure and the piston chamber should be vented.
- For further facts and additional applications features see operating instruction MAPnkz-2.

PNEUMATIC POWER CYLINDERS

Functions

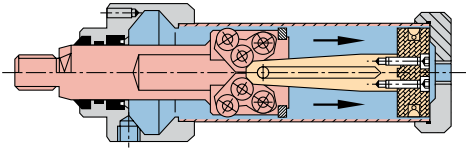

Basic position

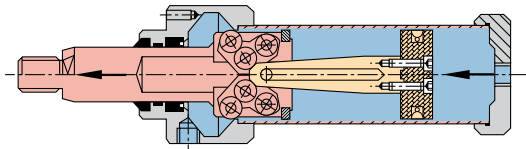

Forward stroke

Piston force is identical to the force of a common pneumatic cylinder with adequate piston diameter

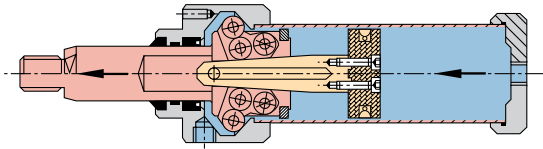

Power stroke

Beginning of mechanical force amplification. Mechanical advantage max. 10:1

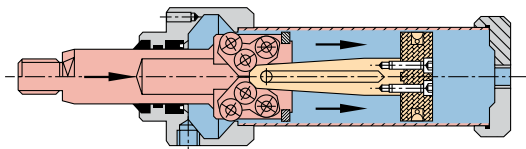

Return stroke

The return stroke can be initiated in any position of piston. The force during return stroke is approx. half of piston force.

Forces

Force within forward stroke

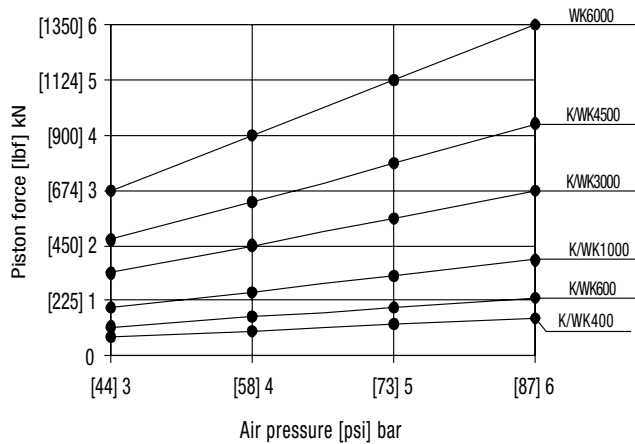

Clamping force within power stroke

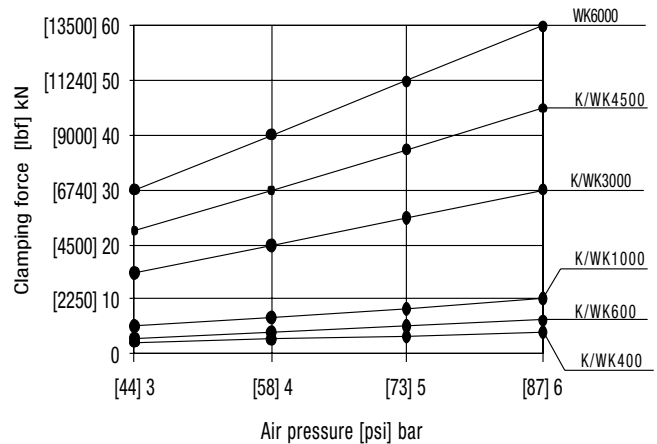

Return stroke force: half of piston force

TYPE K SERIES

Pneumatic Power Cylinders | Product Overview | Technical Information



- Piston rod with male thread

Note:

Operating pressure max. 6 bar [87psi], min 3 bar [44psi]. Use only clean, water- and oilfree compressed air. Piston rod is not secured against twisting and should not be loaded transversal.

See page MC-PPC-2 for more information.

Model	Piston force within forward stroke at 6 bar kN [lbf]	Forward stroke mm [in]	Clamping force within power stroke at 6 bar kN [lbf]	Power stroke mm [in]	Piston dia. mm [in]	Air consumption per double stroke at 6 bar dm ³ [ft ³]	Stroke frequency depending on total stroke [min ⁻¹]	Temperature range °C [°F]	Weight Kg [lbs]
K400-15-6-1	0,68 [153]	15 [0.59]	4 [900lbf]	6 [0.24]	40 [1.75]	0,71 [0.025]	5 to 30	- 5 to +75 [23 to 167]	1,20 [2.6]
K400-30-6-1		30 [1.18]				0,89 [0.031]			1,25 [2.8]
K400-50-6-1		50 [1.97]				1,14 [0.040]			1,30 [2.9]
K400-70-6-1		70 [2.76]				1,38 [0.049]			1,35 [3.0]
K400-120-6-1		120 [4.72]				1,98 [0.070]			1,50 [3.3]
K400-200-6-1	200 [7.87]	2,94 [0.104]	1,70 [3.7]						
K600-15-6-1	1,06 [238]	15 [0.59]	6 [1350lbf]	6 [0.24]	50 [1.97]	1,34 [0.047]	5 to 30	- 5 to +75 [23 to 167]	2,05 [4.5]
K600-30-6-1		30 [1.18]				1,65 [0.058]			2,15 [4.7]
K600-50-6-1		50 [1.97]				2,06 [0.073]			2,30 [5.1]
K600-70-6-1		70 [2.76]				2,47 [0.087]			2,40 [5.3]
K600-120-6-1		120 [4.72]				3,50 [0.124]			2,70 [6.0]
K600-200-6-1	200 [7.87]	5,15 [0.182]	3,20 [7.1]						
K1000-15-7-1	1,75 [393]	15 [0.59]	10 [2250lbf]	7* [0.27]	63 [2.48]	2,20 [0.078]	5 to 30	- 5 to +75 [23 to 167]	3,60 [7.9]
K1000-30-7-1		30 [1.18]				2,66 [0.094]			3,80 [8.4]
K1000-50-7-1		50 [1.97]				3,26 [0.115]			4,10 [9.0]
K1000-70-7-1		70 [2.76]				3,85 [0.136]			4,40 [9.7]
K1000-120-7-1		120 [4.72]				5,35 [0.189]			5,20 [11.5]
K1000-200-7-1	200 [7.87]	7,74 [0.273]	6,40 [14.1]						
K3000-15-6-1	3 [674]	15 [0.59]	30 [6700lbf]	6* [0.24]	85 [3.35]	4,48 [0.158]	5 to 25	- 5 to +75 [23 to 167]	11,80 [26.0]
K3000-30-6-1		30 [1.18]				5,20 [0.184]			12,50 [27.6]
K3000-50-6-1		50 [1.97]				6,17 [0.218]			13,40 [29.5]
K3000-70-6-1		70 [2.76]				7,13 [0.252]			14,30 [31.5]
K3000-120-6-1		120 [4.72]				9,54 [0.337]			16,60 [36.6]
K3000-200-6-1	200 [7.87]	13,40 [0.473]	20,20 [44.5]						
K4500-15-6-1	4,2 [944]	15 [0.59]	45 [10120lbf]	6* [0.24]	100 [3.94]	6,18 [0.218]	5 to 25	- 5 to +75 [23 to 167]	13,30 [29.3]
K4500-30-6-1		30 [1.18]				7,17 [0.253]			14,00 [30.9]
K4500-50-6-1		50 [1.97]				8,50 [0.300]			15,00 [33.1]
K4500-70-6-1		70 [2.76]				9,83 [0.347]			15,80 [34.8]
K4500-120-6-1		120 [4.72]				13,20 [0.466]			18,10 [39.9]
K4500-200-6-1	200 [7.87]	18,50 [0.653]	21,70 [47.8]						

* Power strokes up to 12 mm and other forward strokes upon request

TYPE K SERIES

Pneumatic Power Cylinders | Technical Information

Type K in standard version

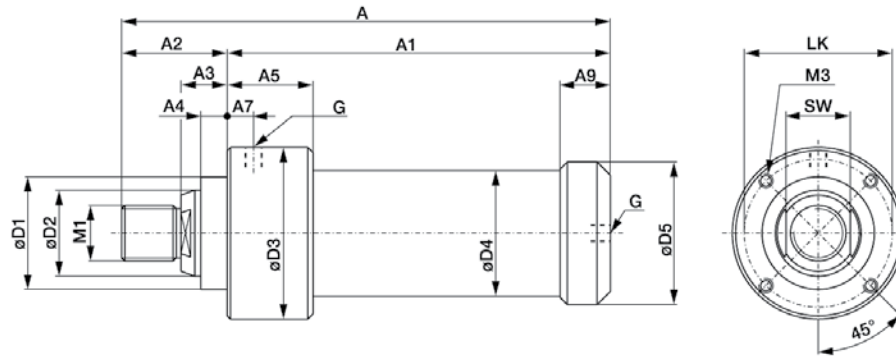

Model	Dimensions for standard version of type K Differences of dimensions for cylinder with magnet piston rings see chart on page MC-PPC-10																	
	A	A ₁	A ₂	A ₃	A ₄	A ₅	A ₇	A ₉	ø D ₁	ø D ₂	ø D ₃	ø D ₄	ø D ₅	M ₁	M ₃	LK	SW	G
K400-15-6-1	186 [7.32]	145 [5.71]																
K400-30-6-1	201 [7.91]	160 [6.30]																
K400-50-6-1	221 [8.70]	180 [7.09]	41 [1.6]	21 [0.8]	12 [0.5]	39 [1.5]	10 [0.4]	23,5 [0.9]	40 _{h8} [1.6]	25 _{h7} [1.0]	63 [2.5]	44 [1.7]	49 [1.9]	M16 x 1,5 [0.06]	M5, 10mm deep [0.1]	54 [2.1]	21 [0.8]	G1/8
K400-70-6-1	241 [9.49]	200 [7.87]																
K400-120-6-1	291 [11.46]	250 [9.84]																
K400-200-6-1	371 [14.61]	330 [12.99]																
K600-15-6-1	201 [7.91]	160 [6.30]																
K600-30-6-1	216 [8.50]	175 [6.89]																
K600-50-6-1	236 [9.29]	195 [7.68]	41 [1.6]	21 [0.8]	12 [0.5]	39 [1.5]	10 [0.4]	23,5 [0.9]	40 _{h8} [1.6]	25 _{h7} [1.0]	73 [2.9]	54 [2.1]	59 [2.3]	M16 x 1,5 [0.06]	M6, 10mm deep [0.1]	64 [2.5]	21 [0.1]	G1/8
K600-70-6-1	256 [10.08]	215 [8.46]																
K600-120-6-1	306 [12.05]	265 [10.43]																
K600-200-6-1	386 [15.20]	345 [13.58]																
K1000-15-7-1	243 [9.57]	187 [7.36]																
K1000-30-7-1	258 [10.16]	202 [7.95]																
K1000-50-7-1	278 [10.94]	222 [8.74]	56 [2.2]	25 [1.0]	15 [0.6]	52 [2.0]	10 [0.4]	29 [1.1]	63 _{h8} [2.5]	40 _{h7} [1.6]	100 [3.9]	68 [2.7]	74,5 [2.9]	M24 x 3,0 [0.98]	M8, 12mm deep [1]	85 [3.3]	32 [1.3]	G1/8
K1000-70-7-1	298 [11.73]	242 [9.53]																
K1000-120-7-1	348 [13.70]	292 [11.50]																
K1000-200-7-1	428 [16.85]	372 [14.65]																

TYPE K SERIES

Pneumatic Power Cylinders | Technical Information

Type K in standard version

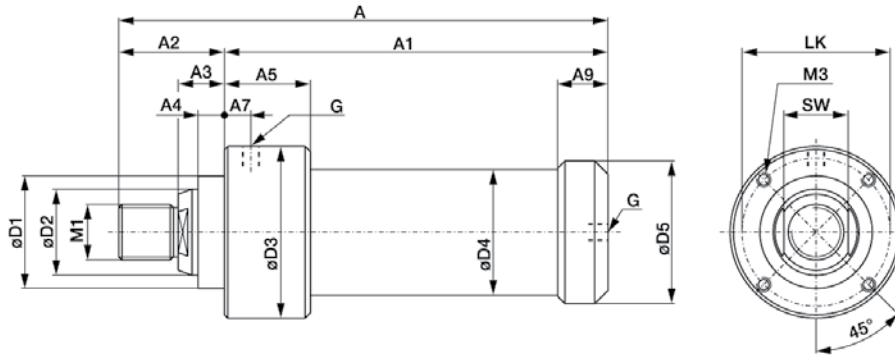

Model	Dimensions for standard version of type K Differences of dimensions for cylinder with magnet piston rings see chart on page MC-PPC-10																		
	A	A ₁	A ₂	A ₃	A ₄	A ₅	A ₇	A ₉	øD ₁	øD ₂	øD ₃	øD ₄	øD ₅	M ₁	M ₃	LK	SW	G	
K3000-15-6-1	315 [12.40]	235 [9.25]																	
K3000-30-6-1	330 [12.99]	250 [9.84]																	
K3000-50-6-1	350 [13.78]	270 [10.63]	50 [2.0]	35 [1.4]	20 [0.8]	70 [2.8]	20 [0.8]	45 [1.8]	85 _{h8} [3.3]	65 _{h7} [2.6]	130 [5.1]	95 [3.7]	108 [4.3]	M42 [1.65]	M10, 16mm deep [1.7]	112 [4.4]	55 [2.2]	G1/4	
K3000-70-6-1	370 [14.57]	290 [11.42]																	
K3000-120-6-1	420 [16.54]	340 [13.39]																	
K3000-200-6-1	500 [19.69]	420 [16.54]																	
K4500-15-6-1	315 [12.40]	235 [9.25]																	
K4500-30-6-1	330 [12.99]	250 [9.84]																	
K4500-50-6-1	350 [13.78]	270 [10.63]	80 [3.1]	35 [1.4]	20 [0.8]	70 [2.8]	20 [0.8]	45 [1.8]	85 _{h8} [3.3]	65 _{h7} [2.6]	145 [5.7]	110 [4.3]	123 [4.8]	M42 [1.65]	[1.7] M10, 16mm deep	127 [5.0]	55 [2.2]	G1/4	
K4500-70-6-1	370 [14.57]	290 [11.42]																	
K4500-120-6-1	420 [16.54]	340 [13.39]																	
K4500-200-6-1	500 [19.69]	420 [16.54]																	

TYPE WK SERIES

Pneumatic Power Cylinders | Product Overview | Technical Information



- Piston rod with ISO fit

Note:

Operating pressure max. [87psi]6 bar, min [44psi] 3 bar. Use only clean, water- and oilfree compressed air. Piston rod is not secured against twisting and should not be loaded transversal.

See page MC-PPC-2 for more information.

Model	Piston force within forward stroke at 6 bar kN [lbf]	Forward stroke mm [in]	Clamping force within power stroke at 6 bar kN [lbf]	Power stroke mm [in]	Piston dia. mm [in]	Air consumption per double stroke at 6 bar dm ³ [ft ³]	Stroke frequency depending on total stroke [min ⁻¹]	Temperature range °C [°F]	Weight [lbs] kg
WK400-15-6-1	0,68 [153]	15 [0.59]	4 [900lbf]	6 [0.24]	40 [1.75]	0,71 [0.025]	5 to 30	- 5 to +75 [23 to 167]	1,20 [2.6]
WK400-30-6-1		30 [1.18]				0,89 [0.031]			1,25 [2.8]
WK400-50-6-1		50 [1.97]				1,14 [0.040]			1,30 [2.9]
WK400-70-6-1		70 [2.76]				1,38 [0.049]			1,35 [3.0]
WK400-120-6-1		120 [4.72]				1,98 [0.070]			1,50 [3.3]
WK400-200-6-1		200 [7.87]				2,94 [0.104]			1,70 [3.7]
WK600-15-6-1	1,06 [238]	15 [0.59]	6 [1350lbf]	6 [0.24]	50 [1.97]	1,34 [0.047]	5 to 30	- 5 to +75 [23 to 167]	2,05 [4.5]
WK600-30-6-1		30 [1.18]				1,65 [0.058]			2,15 [4.7]
WK600-50-6-1		50 [1.97]				2,06 [0.073]			2,30 [5.1]
WK600-70-6-1		70 [2.76]				2,47 [0.087]			2,40 [5.3]
WK600-120-6-1		120 [4.72]				3,50 [0.124]			2,70 [6.0]
WK600-200-6-1		200 [7.87]				5,15 [0.182]			3,20 [7.1]
WK1000-15-7-1	1,75 [393]	15 [0.59]	10 [2250lbf]	7* [0.27]	63 [2.48]	2,20 [0.078]	5 to 30	- 5 to +75 [23 to 167]	3,60 [7.9]
WK1000-30-7-1		30 [1.18]				2,66 [0.094]			3,80 [8.4]
WK1000-50-7-1		50 [1.97]				3,26 [0.115]			4,10 [9.0]
WK1000-70-7-1		70 [2.76]				3,85 [0.136]			4,40 [9.7]
WK1000-120-7-1		120 [4.72]				5,35 [0.189]			5,20 [11.5]
WK1000-200-7-1		200 [7.87]				7,74 [0.273]			6,40 [14.1]
WK3000-15-6-1	3 [674]	15 [0.59]	30 [6700lbf]	6* [0.24]	85 [3.35]	4,48 [0.158]	5 to 25	- 5 to +75 [23 to 167]	11,80 [26.0]
WK3000-30-6-1		30 [1.18]				5,20 [0.184]			12,50 [27.6]
WK3000-50-6-1		50 [1.97]				6,17 [0.218]			13,40 [29.5]
WK3000-70-6-1		70 [2.76]				7,13 [0.252]			14,30 [31.5]
WK3000-120-6-1		120 [4.72]				9,54 [0.337]			16,60 [36.6]
WK3000-200-6-1		200 [7.87]				13,40 [0.473]			20,20 [44.5]
WK4500-15-6-1	4,2 [944]	15 [0.59]	45 [10120lbf]	6* [0.24]	100 [3.94]	6,18 [0.218]	5 to 25	- 5 to +75 [23 to 167]	13,30 [29.3]
WK4500-30-6-1		30 [1.18]				7,17 [0.253]			14,00 [30.9]
WK4500-50-6-1		50 [1.97]				8,50 [0.300]			15,00 [33.1]
WK4500-70-6-1		70 [2.76]				9,83 [0.347]			15,80 [34.8]
WK4500-120-6-1		120 [4.72]				13,20 [0.466]			18,10 [39.9]
WK4500-200-6-1		200 [7.87]				18,50 [0.653]			21,70 [47.8]
WK6000-30-6	6,0 [1350]	[1.18] 30	60,0 [13490lbf]	6* [0.24]	125,0 [4.92]	[0.367] 10,40	5 to 25	- 5 to +75 [23 to 167]	24,00 [52.9]
WK6000-50-6		[1.97] 50				[0.454] 12,85			24,50 [54.0]
WK6000-70-6		[2.76] 70				[0.536] 15,17			25,00 [55.1]
WK6000-120-6		[4.72] 120				[0.747] 21,15			26,50 [58.4]

* Power strokes up to 12 mm and other forward strokes upon request

TYPE WK SERIES

Pneumatic Power Cylinders | Technical Information

Type WK in standard version

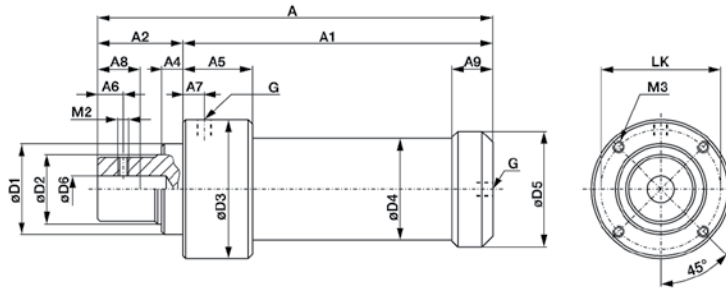

Model	Dimensions for standard version of type WK																		
	Differences of dimensions for cylinder with magnet piston rings see chart on page MC-PPC-10																		
	A	A ₁	A ₂	A ₃	A ₄	A ₅	A ₇	A ₈ **	A ₉	Ø D ₁	Ø D ₂	Ø D ₃	Ø D ₄	Ø D ₅	Ø D ₆	M ₂	M ₃	LK	G
WK400-15-6-1	186 [7.32]	145 [5.71]																	
WK400-30-6-1	201 [7.91]	160 [6.30]																	
WK400-50-6-1	221 [8.70]	180 [7.09]	41 [1.61]	21 [0.83]	12 [0.47]	39 [1.54]	10 [0.39]	25 [0.98]	23,5 [0.93]	40 _{h7} [1.57]	25 _{h7} [0.98]	63 [2.48]	44 [1.73]	49 [1.93]	10 ^{H7}	M6	M5, 10mm deep [0.06]	54 [2.13]	G1/8
WK400-70-6-1	241 [9.49]	200 [7.87]																	
WK400-120-6-1	291 [11.46]	250 [9.84]																	
WK400-200-6-1	371 [14.61]	330 [12.99]																	
WK600-15-6-1	201 [7.91]	160 [6.30]																	
WK600-30-6-1	216 [8.50]	175 [6.89]																	
WK600-50-6-1	236 [9.29]	195 [7.68]	41 [1.61]	21 [0.83]	12 [0.47]	39 [1.54]	10 [0.39]	25 [0.98]	23,5 [0.93]	40 _{h7} [1.57]	25 _{h7} [0.98]	73 [2.87]	54 [2.13]	[2.32] 59	10 ^{H7}	M6	M6, 10mm deep [0.06]	64 [2.52]	G1/8
WK600-70-6-1	256 [10.08]	215 [8.46]																	
WK600-120-6-1	306 [12.05]	265 [10.43]																	
WK600-200-6-1	386 [15.20]	345 [13.58]																	
WK1000-15-7-1	243 [9.57]	187 [7.36]																	
WK1000-30-7-1	258 [10.16]	202 [7.95]																	
WK1000-50-7-1	278 [10.94]	222 [8.74]	56 [2.20]	25 [0.98]	15 [0.59]	52 [2.05]	10 [0.39]	40 [1.57]	29 [1.14]	63 _{h8} [2.48]	40 _{h7} [1.57]	99,5 [3.92]	68 [2.68]	74,5 [2.93]	20 ^{H7}	M8	M8, 12mm deep [0.98]	85 [3.35]	G1/8
WK1000-70-7-1	298 [11.73]	242 [9.53]																	
WK1000-120-7-1	348 [13.70]	292 [11.50]																	
WK1000-200-7-1	428 [16.85]	372 [14.65]																	

Continued on next page

TYPE WK SERIES

Pneumatic Power Cylinders | Technical Information

Type WK in standard version

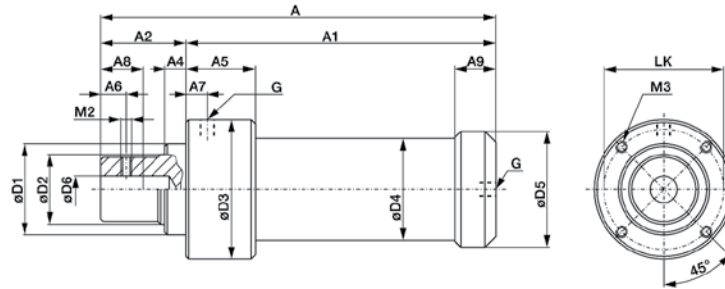

Model	Dimensions for standard version of type WK Differences of dimensions for cylinder with magnet piston rings see chart on page MC-PPC-10																		
	A	A ₁	A ₂	A ₃	A ₄	A ₅	A ₇	A ₈ **	A ₉	Ø D ₁	Ø D ₂	Ø D ₃	Ø D ₄	Ø D ₅	Ø D ₆	M ₂	M ₃	LK	G
WK3000-15-6-1	315 [12.40]	235 [9.25]																	
WK3000-30-6-1	330 [12.99]	250 [9.84]																	
WK3000-50-6-1	350 [13.78]	270 [10.63]	80 [3.15]	35 [1.38]	20 [0.79]	70 [2.76]	20 [0.79]	40 [1.57]	45 [1.77]	85 _{h8} [3.35]	65 _{h7} [2.56]	130 [5.12]	95 [3.74]	108 [4.25]	25 ^{H7}	M10	M10, 16mm deep [16]	112 [4.41]	G1/4
WK3000-70-6-1	370 [14.57]	290 [11.42]																	
WK3000-120-6-1	420 [16.54]	340 [13.39]																	
WK3000-200-6-1	500 [19.69]	420 [16.54]																	
WK4500-15-6-1	315 [12.40]	235 [9.25]																	
WK4500-30-6-1	330 [12.99]	250 [9.84]																	
WK4500-50-6-1	350 [13.78]	270 [10.63]	80 [3.15]	35 [1.38]	20 [0.79]	70 [2.76]	20 [0.79]	40 [1.57]	45 [1.77]	85 _{h8} [3.35]	65 _{h7} [2.56]	145 [5.71]	110 [4.33]	123 [4.84]	25 ^{H7}	M10	M10, 16mm deep [1.65]	127 [5.00]	G1/4
WK4500-70-6-1	370 [14.57]	290 [11.42]																	
WK4500-120-6-1	420 [16.54]	340 [13.39]																	
WK4500-200-6-1	500 [19.69]	420 [16.54]																	
WK6000-30-6	365 [14.37]	285 [11.22]																	
WK6000-50-6	385 [15.16]	305 [12.01]	80 [3.15]	20 [0.79]	48 [1.89]	24 [0.94]	22 [0.87]	40 [1.57]	53 [2.09]	85 _{h8} [3.35]	65 _{h7} [2.56]	178 [7.01]	135 [5.31]	148 [5.83]	25 ^{H7}	M10	M10, 16mm deep [1.65]	150 [5.91]	G1/2
WK6000-70-6	405 [15.94]	325 [12.80]																	
WK6000-120-6	455 [17.91]	375 [14.76]																	

** Usable depth of bore with ISO fit D6

TYPE WR SERIES

Pneumatic Power Cylinders | Product Overview

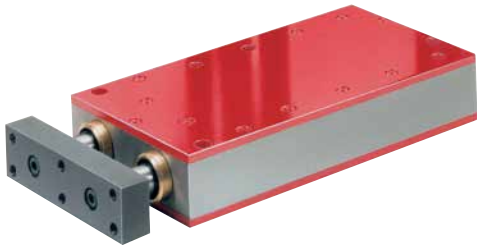

- Piston rods prevent twisting

Note:

Use only clean, water- and oilfree compressed air. Force must be transmitted via the centre of the pressure plate. One-sided loading of the pressure plate should be avoided. For punching applications contact our technical support! See page MC-PPC-2 for more information.

Type WR

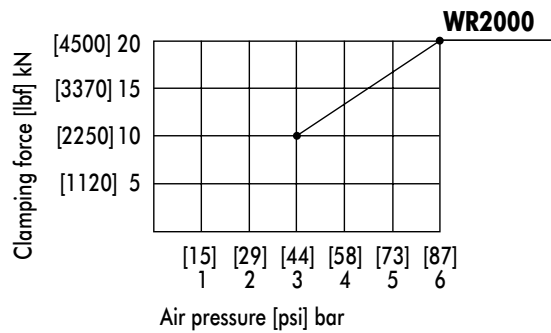
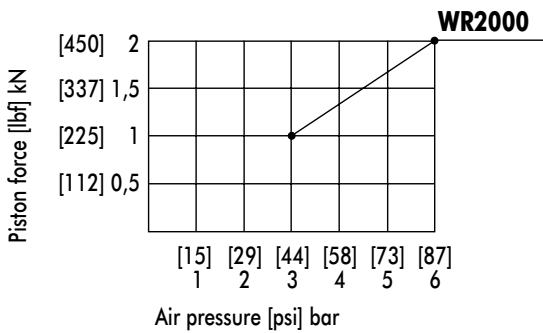
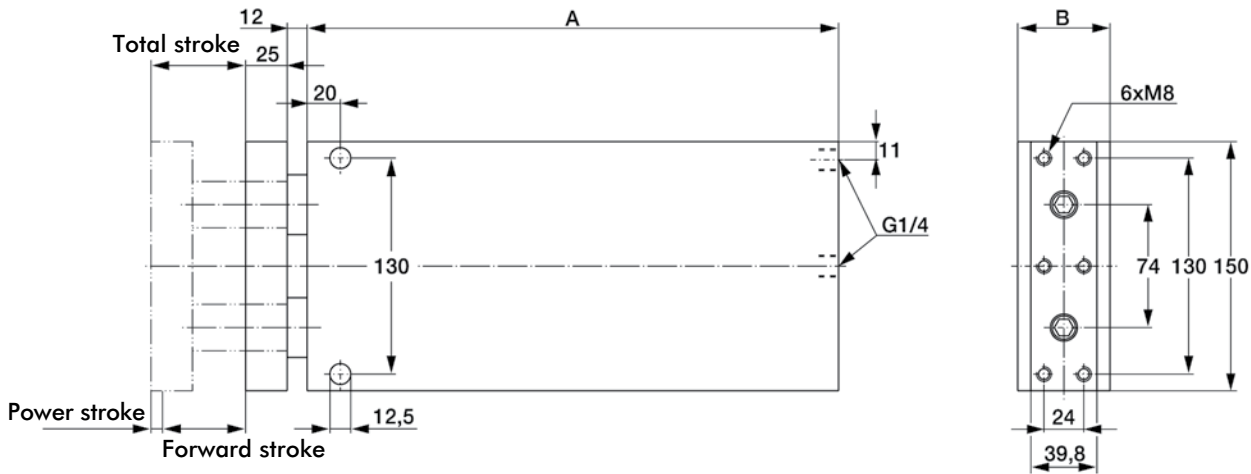

Return stroke force: half of piston force

Air pressure: max. [87psi] 6 bar; min. [44psi] 3 bar

Model	Piston force within forward stroke at 6 bar kN [lbf]	Forward stroke mm [in]	Clamping force within power stroke at 6 bar [lbf] kN	Power stroke mm [in]	Piston dia. mm [in]	Air consumption per double stroke at 6 bar dm ³ [ft ³]	Stroke frequency depending on total stroke [min ⁻¹]	Temperature range °C [°F]	Weight kg [lbs]	A	B
WR 2000-15-7		15 [0.59]				2,44 [0.086]			12,5 [27.6]	285	51,6
WR 2000-30-7		30 [1.18]				2,95 [0.104]			14,0 [30.9]	300	51,6
WR 2000-50-7	2 [450]	50 [1.97]	20 [4500]	7 [0.27]	70 [2.76]	3,62 [0.128]	5 - 25	-5 up to +75 [23 to up167]	15,5 [34.1]	320	55,6
WR 2000-70-7		70 [2.76]				4,27 [0.151]			17,2 [37.9]	340	55,6
WR 2000-120-7		120 [4.72]				5,94 [0.210]			21,0 [46.3]	390	59,6

Pneumatic Power Cylinders Type K and WK with end position control by magnetic field sensors.

- **For the sizes**
K and WK 400.... , K and WK 600... ,
K and WK 1000.... K and WK 3000...,
K and WK 4500...
- **Change of Model**
Indicate „-A“ at the end of Model instead of „-1“
for standard version!
Example:
K400 – 15 – 6 – 1 change to K400 – 15 – 6 – A
WK 3000 – 50 – 6 – 1 change to WK 3000 – 50 – 6 – A
- **Change in construction**
Only the dimensions Ø D4, Ø D5, A/A 1 and A9 are
different to the standard version.



- **Standard equipment (as shown above)**
Pneumatic Power Cylinders with „-A“ at the end of
Model are completely furnished with a magnetic
piston ring and with two mounted sensor sets
(Model SMB-102157, consisting of magnetic field
sensor with 3m cable, clamp and strap)

Type K

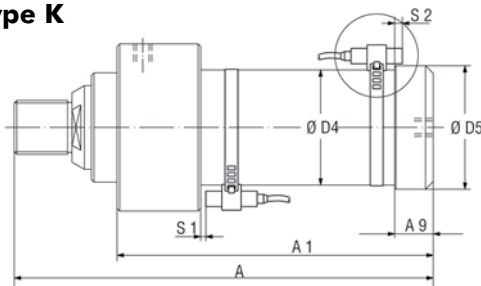

For sizes	Switching points of sensors		**Differences of dimensions compared with standard version				
	S1*	S2*	Ø D4	Ø D5	A/A 1	A9	Rs
K 400-...-A	5	12	-	-	+15	-	44
K 1000-...-A	10	18	-	-	+15	-	56
K 3000-...-A	5	14	90	97	-	30	67
K 45000-...-A	5	12	106	113	-	28,5	75

* Approx. data, because of magnet field variations. S1 refers to the max. power stroke and enlarges up to 60 mm, when smaller power strokes are used.

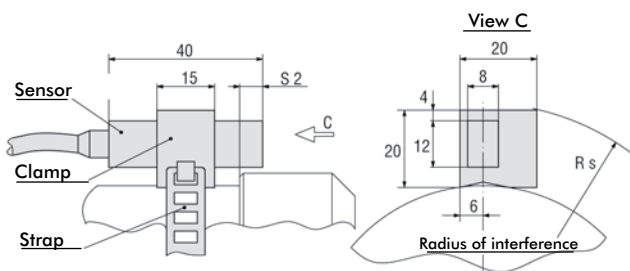

Circuit diagram and technical data of sensor set Model **SMB-102157**, consisting of magnetic field sensor with 3 m cable, clamp and strap (2 sets per cylinder are standard equipment).

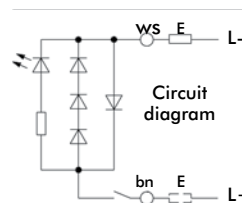

Switching voltage	10...250 VAC/DC
Switching current	0,5 A
Switching power	20 W/30 VA
Function	normally open contact
Protection class	IP 67 (DIN 40050)
Indicator	LED

Type WK

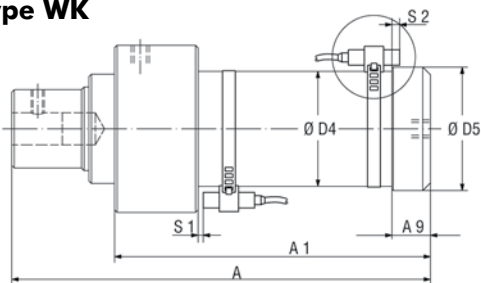

For sizes	Switching points of sensors		**Differences of dimensions compared with standard version				
	S1*	S2*	Ø D4	Ø D5	A/A 1	A9	Rs
WK 400-...-A	5	12	-	-	+15	-	44
WK 1000-...-A	10	18	-	-	+15	-	56
WK 3000-...-A	5	14	90	97	-	30	67
WK 45000-...-A	5	12	106	113	-	28,5	75

* Approx. data, because of magnet field variations. S1 refers to the max. power stroke and enlarges up to 60 mm, when smaller power strokes are used.

-K OPTION

Magnetic Field Sensing | Technical Specifications



Sensor cage for T-slot proximity sensor

- **For the sizes**
K and WK 400.... , K and WK 600... , K and WK 1000.... ,
K and WK 3000..., K and WK 4500...
- **Change of Model**
Indicate "-K" at the end of Model instead of "-A" for
standard version.
Example:
K400 – 15 – 6 – A change to K400 – 15 – 6 – K
WK 3000 – 50 – 6 – A change to WK 3000 - 50 – 6 – K
- **Benefits:**
Small radii of interference.
Customer specific T-slot sensors are usable.
- **Standard equipment:**
Pneumatic power cylinder with "-K" at the end of Model
number are supplied with mounted sensor cages but
without T-slot sensors.

PNEUMATIC POWER CYLINDERS

Application Examples



Radius clinching unit for profiled aluminium

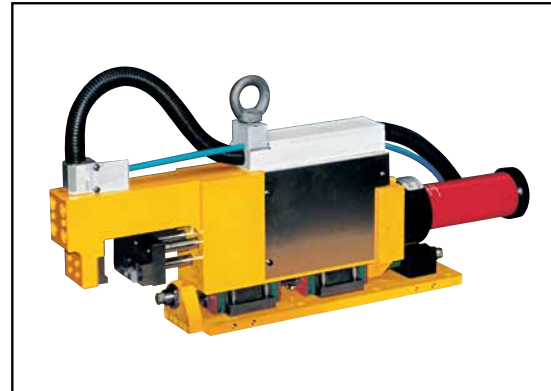

Special punching unit for 2 holes Ø 3,4 in steel 0,9 mm

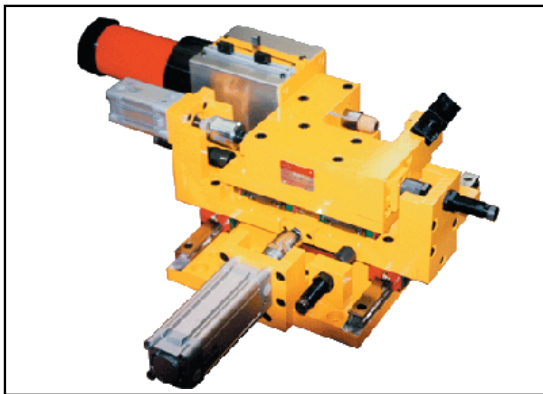

Special device for 2 holes Ø 12 in steel 1,2 mm

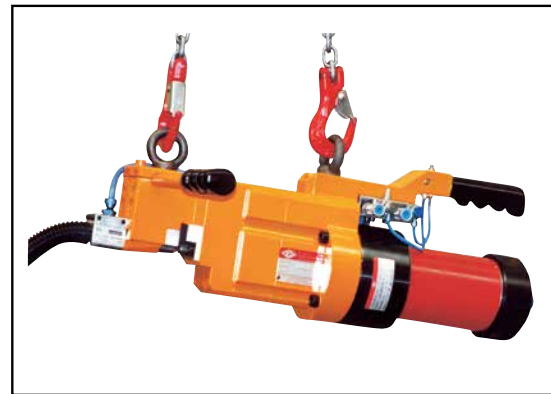

Mobile punching unit for holes Ø 6,2 in crossbeams



Device for holes Ø 8 in sheet metal



Stamping units placed in line



Stamping units placed in line



Welding fixture for exhaust components