

RP5-10 SERIES

2-Jaw General Industrial Grippers | Product Features, How to Order

Features:

- Widely used robust miniature gripper
- Double wedge design for high impact applications
- Spring assist option for part retention in case of air pressure loss
- Create gripper arrays with close proximity mounting for multiple part pick and place
- Grip force range from 156N [35 lbs] to 178N [40 lbs]
- Stroke Range from 4.1mm [0.16 in] to 6.4mm [0.25 in]

Applications:

- Ideal for small part gripping solutions
- Used with small robots
- Packaging applications
- Multiple part transfers using banks of grippers

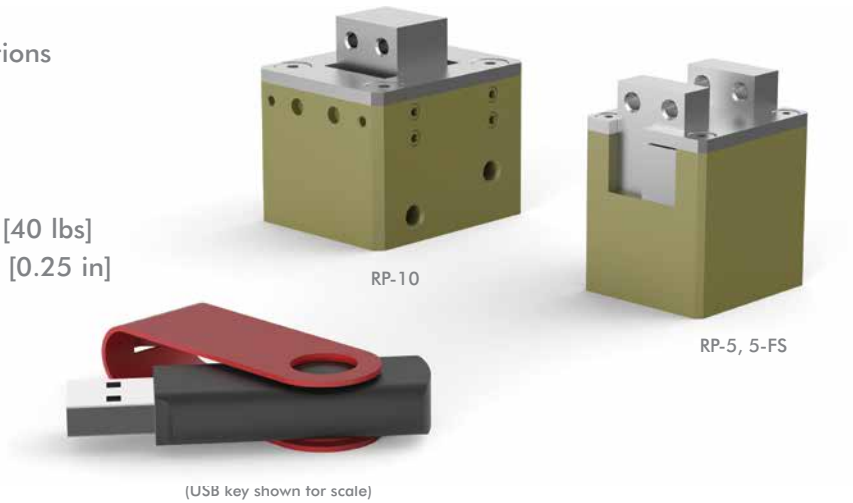

How To Order

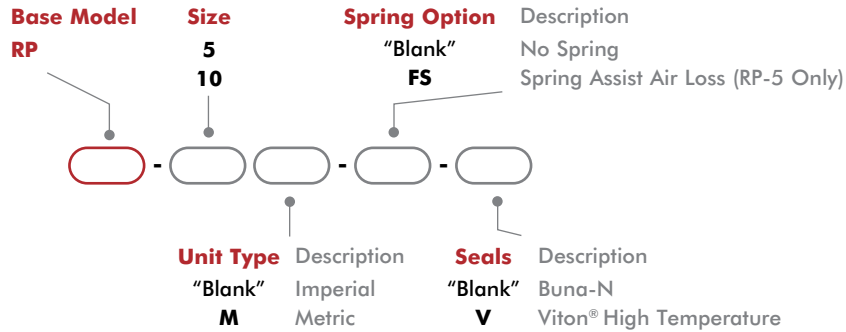

Accessories

Sensor Accessories	Model Numbers	Part Number	Qty/Unit
Sensor Mounting Kit for Imperial & Metric Units (mounts 2 sensors)	RP-5	OSMK-001	1
Sensor Mounting Kit for Imperial & Metric Units (mounts 2 sensors)	RP-10	OSMK-002	1
NPN Inductive Sensor with Quick Disconnect*	All Models	OISN-019	1-2
PNP Inductive Sensor with Quick Disconnect*	All Models	OISP-019	1-2
Quick Disconnect 2 Meter Cable Length*	All Models	CABL-010	1-2
Quick Disconnect 5 Meter Cable Length*	All Models	CABL-013	1-2

Pneumatic Accessories	Model Numbers	Part Number	Qty/Unit
Fail Safe Valve (Imperial)	All Models	OFSV-001	1
Fail Safe Valve (Metric)	All Models	OFSV-004	1

* Sensor and cable sold separately.

RP5-10 SERIES

2-Jaw General Industrial Grippers | Technical Specifications

Specifications	Units	5	5-FS	10
Total Rated Grip Force F @ 100 psi [7 bar]	N [lbs]	156 [35]	178 [40]	
Total Stroke	mm [in]	4.1 [0.16]		6.4 [0.25]
Weight	kg [lbs]	0.08 [0.18]		0.13 [0.28]
Pressure Range	bar [psi]	3-7 [40-100]		
Ingress Protection Class (IP)		IP43		
Displacement	cm ³ [in ³]	0.7 [0.042]		1.6 [0.098]
Temperature Range (Buna-N seals)	°C [°F]	-35°~80° [-30°~180°]		
Temperature Range (Viton® seals)	°C [°F]	-30°~150° [-20°~300°]		
Actuation	sec	0.14		0.13
Accuracy	mm [in]	±0.03 [±0.001]		
Repeatability	mm [in]	±0.01 [±0.0005]		
Valve to Actuate		4-way, 2-position		

RP-5

2-Jaw Parallel Grippers | Dimensions and Technical Specifications

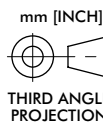
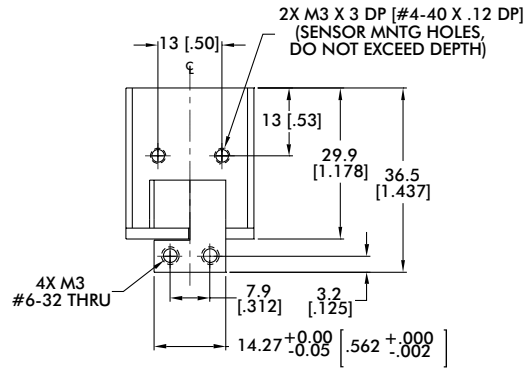
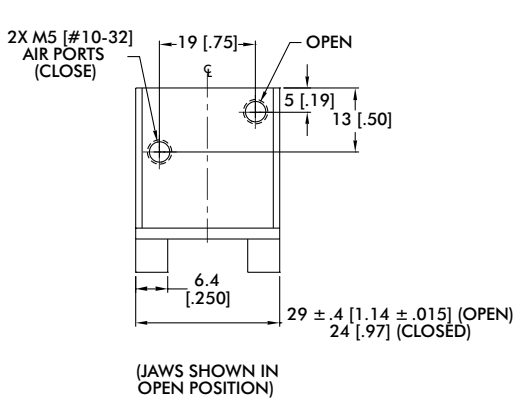
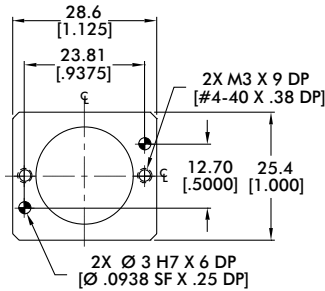

Seal Repair Kits	RP-5
Buna-N Seal Repair Kit	SLKT-052
Viton® Seal Repair Kit	SLKT-052V

Loading Information

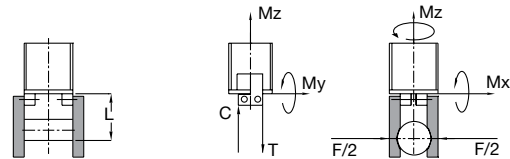
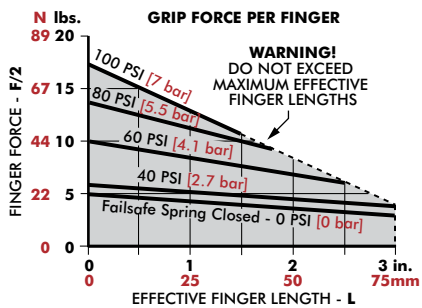

RP-5	Static	Dynamic
Maximum Tensile T	222 N [50 lbs]	31 N [7 lbs]
Maximum Compressive C	334 N [75 lbs]	53 N [12 lbs]
Maximum Moment M_x	3.4 Nm [30 in-lbs]	0.6 Nm [5 in-lbs]
Maximum Moment M_y	3.4 Nm [30 in-lbs]	0.6 Nm [5 in-lbs]
Maximum Moment M_z	3.4 Nm [30 in-lbs]	0.6 Nm [5 in-lbs]

*Capacities are per set of jaws and are not simultaneous

2-Jaw Parallel Grippers | Dimensions and Technical Specifications

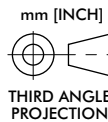
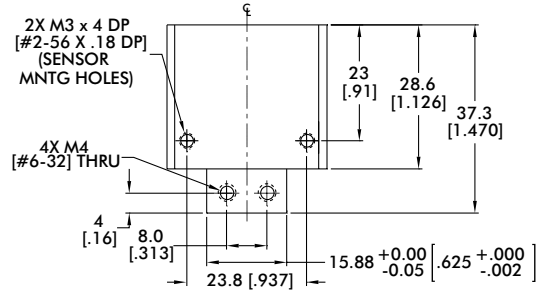
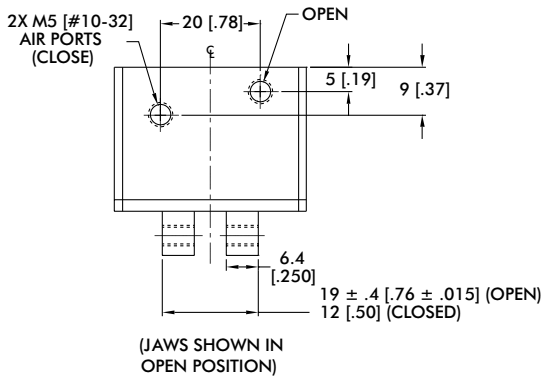
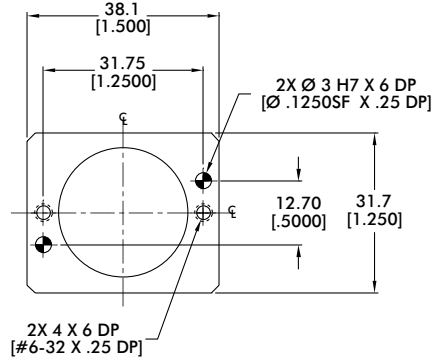

Seal Repair Kits	RP-10
Buna-N Seal Repair Kit	SLKT-036
Viton® Seal Repair Kit	SLKT-036V

Loading Information

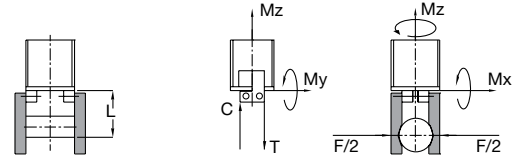
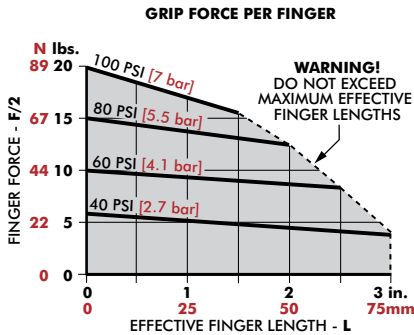

RP-10	Static	Dynamic
Maximum Tensile T	445 N [100 lbs]	67 N [15 lbs]
Maximum Compressive C	667 N [150 lbs]	111 N [25 lbs]
Maximum Moment M_x	10.2 Nm [90 in-lbs]	1.5 Nm [15 in-lbs]
Maximum Moment M_y	10.2 Nm [90 in-lbs]	1.5 Nm [15 in-lbs]
Maximum Moment M_z	10.2 Nm [90 in-lbs]	1.5 Nm [15 in-lbs]

*Capacities are per set of jaws and are not simultaneous