

DPG SERIES

2-Jaw General Industrial Grippers | Features and Benefits | How To Order

Features:

- Rugged general purpose modular gripper
- Multi-position sensing up to 4 locations
- Shielded gripper to repel metal chips and particulates
- Spring assist option maintains grip in case of air pressure loss
- Synchronous or non-synchronous jaw operation
- Multiple air ports support manifold interface using O-rings
- Two finger mounting surfaces on each jaw

Applications:

- CNC Machining applications
- Chip and dry particulate harsh environments
- Non-synchronous jaw or fixed jaw clamp operations



(USB key shown for scale)

How To Order

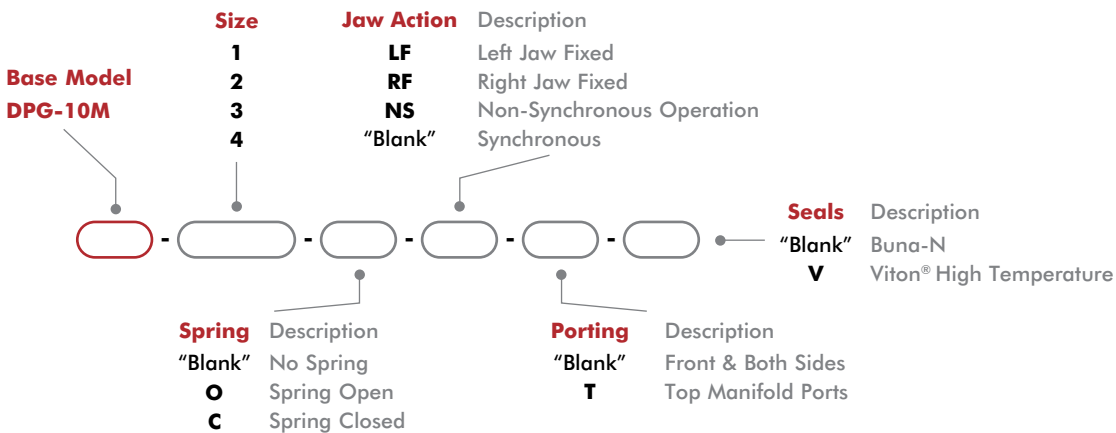

2-Jaw General Industrial Grippers | How To Order, Technical Specifications

Sensor Accessories	Model Numbers	Part Number	Qty/Unit
Inductive Sensor Mounting Kit (Mounts 2 Sensors)	All Models	OSMK-097	1-2
NPN Inductive Sensor with Qk. Disconnect*	All Models	OISN-019	1-4
PNP Inductive Sensor with Qk. Disconnect*	All Models	OISP-019	1-4
NPN Magneto Resistive Sensor w/Qk. Disconnect*	All Models	OHSN-017	1-4
PNP Magneto Resistive Sensor w/Qk. Disconnect*	All Models	OHSP-017	1-4
NPN Magneto Resistive Sensor (90°) w/Qk. Disconnect*	All Models	OHSN-011	1-4
PNP Magneto Resistive Sensor (90°) w/Qk. Disconnect*	All Models	OHSP-011	1-4
Quick Disconnect Cable (2 meters long)*	All Models	CABL-010	1-4
Quick Disconnect Cable (5 meters long)*	All Models	CABL-013	1-4
Quick Disconnect Cable Extension Cord (1 meter long)*	All Models	CABL-015	1-4
Quick Disconnect Cable Extension Cord (2 meters long)*	All Models	CABL-016	1-4

Pneumatic Accessories	Model Numbers	Part Number	Qty/Unit
Buna-N Seal Repair Kit	All Models	SLKT-183	1
Viton® Seal Repair Kit	All Models	SLKT-183V	1
-T Plumbing Fitting - M3 male to 3mm OD Tube Push-in Style	All Models	PLFT-021	1-2
-T Plumbing Fitting - M3 male to 2mm ID Tube Barb Style	All Models	PLFT-022	1-2
Fail Safe Valve - M5 (Metric)	All Models	OFSV-004	1
Adjustable Flow Control (Metric)	All Models	VLVF-008	1-2
Top Port Manifold Seal Kit	All Models	SLKT-184V	1

*Sensor and cable sold separately.

Specifications

Specifications	Units	10M-1	10M-2	10M-3	10M-4
Total Rated Grip Force F @ 100 psi [7 bar]	N [lbs]	222 [50]			
Total Stroke	mm [in]	6.4 [0.25]	12.7 [0.50]	19.1 [0.75]	25.4 [1.00]
Weight	kg [lbs]	0.17 [0.39]	0.24 [0.53]	0.68 [0.30]	0.81 [0.36]
Pressure Range (without spring)	bar [psi]	3-7 [40-100]			
Pressure Range (with spring)	bar [psi]	1.4-7 [20-100]		3.4-7 [50-100]	
Ingress Protection Class (IP)		IP54			
Displacement	cm ³ [in ³]	1.2 [0.076]	2.5 [0.153]	3.8 [0.230]	5.0 [0.306]
Temperature Range (Buna-N seals)	°C [°F]	-35°~80° [-30°~180°]			
Temperature Range (Viton® seals)	°C [°F]	-30°~150° [-20°~300°]			
Actuation	sec	0.13	0.19	0.29	0.40
Accuracy	mm [in]	±0.05 [±0.002]			
Repeatability	mm [in]	±0.05 [±0.002]			
Valve to Actuate Double Acting		4-way, 2-position			

2-Jaw General Industrial Grippers | Dimensions and Technical Specifications

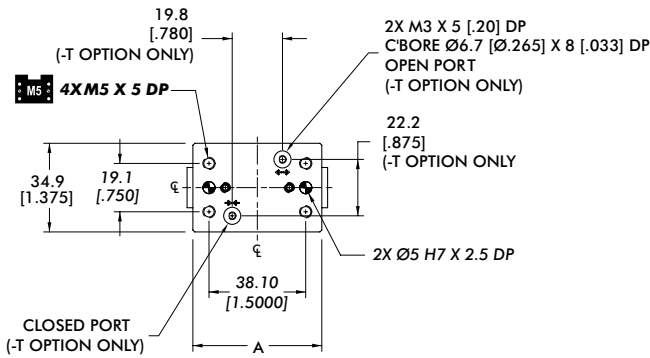

Model	A	B	C	D
DPG-10M-1	50.8 [2.000]	55.6 [2.19]	62.0 [2.44]	29.2 [1.15]
DPG-10M-2	68.3 [2.688]	85.6 [3.37]	72.9 [2.87]	36.8 [1.45]
DPG-10M-3	88.9 [3.500]	93.7 [3.69]	112.8 [4.44]	55.9 [2.20]
DPG-10M-4	106.4 [4.188]	111.3 [4.38]	136.7 [5.38]	61.7 [2.43]

Dimensions in mm [in]

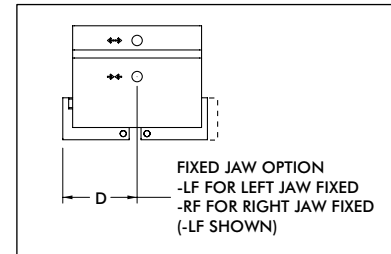
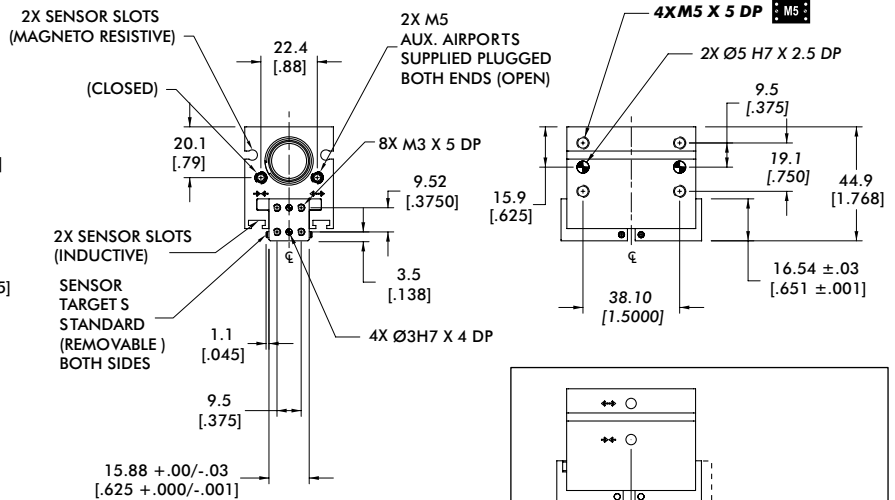
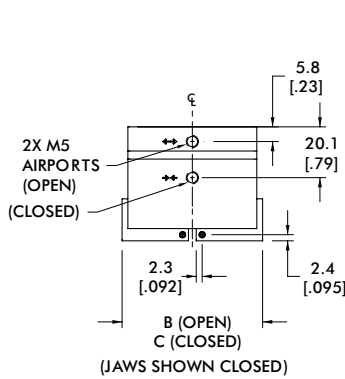

mm [INCH]

THIRD ANGLE PROJECTION

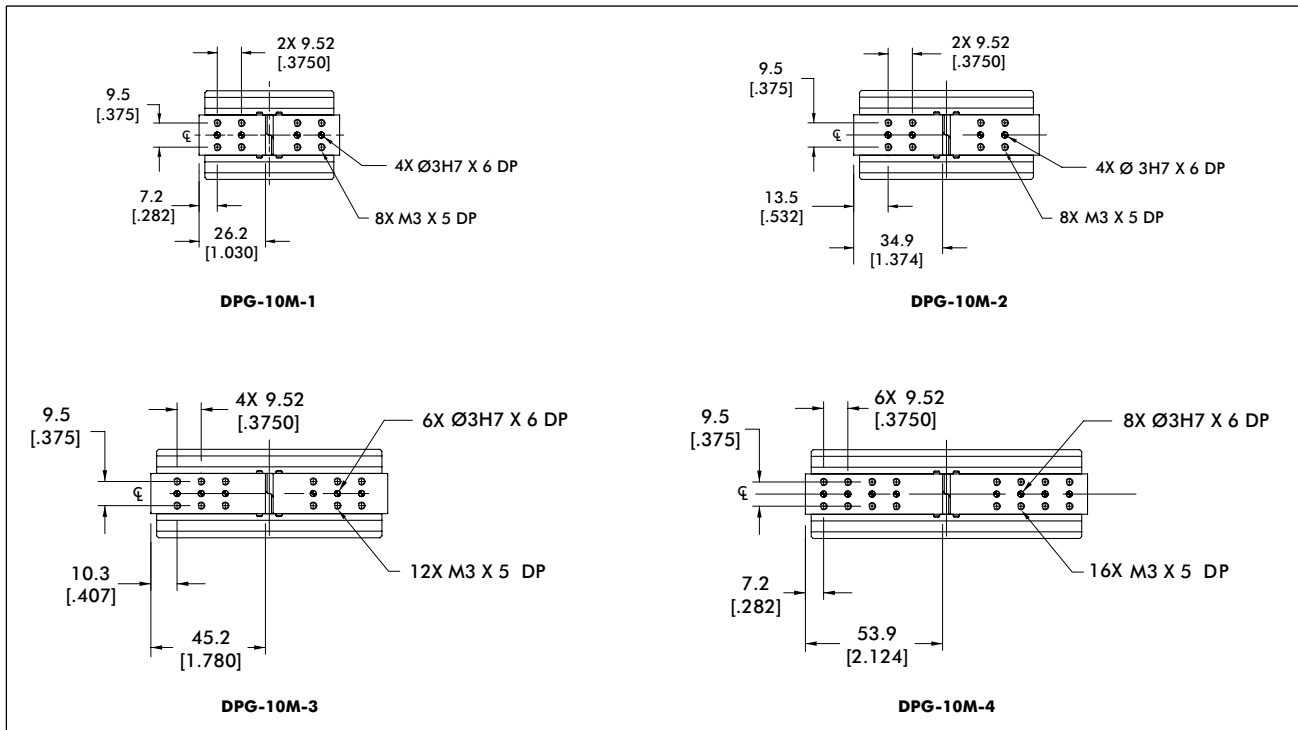

2-Jaw General Industrial Grippers | Loading Capacity

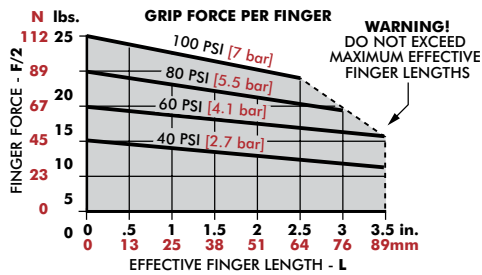

Total Additional Grip Force	Spring Open	Spring Close
@ Full Open	26 N [6 lbs]	40 N [9 lbs]
@ Full Close	49 N [11 lbs]	26 N [6 lbs]

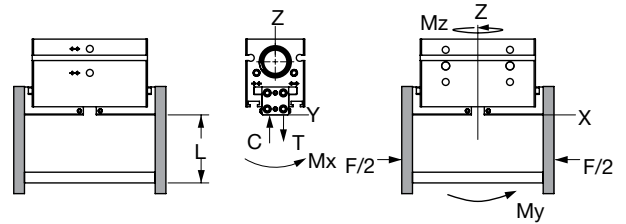

DPG-10M-1	Static	Dynamic
Maximum Tensile T	778 N [175 lbs]	89 N [20 lbs]
Maximum Compressive C	1779 N [400 lbs]	89 N [20 lbs]
Maximum Moment M_x	17 Nm [150 in-lbs]	2 Nm [20 in-lbs]
Maximum Moment M_y	20 Nm [175 in-lbs]	3 Nm [30 in-lbs]
Maximum Moment M_z	17 Nm [150 in-lbs]	2 Nm [20 in-lbs]

*Capacities are per set of jaws and are not simultaneous

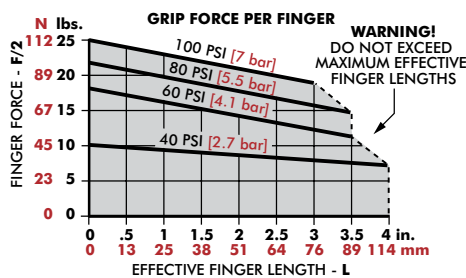

Total Additional Grip Force	Spring Open	Spring Close
@ Full Open	26 N [6 lbs]	62 N [14 lbs]
@ Full Close	66 N [15 lbs]	26 N [6 lbs]

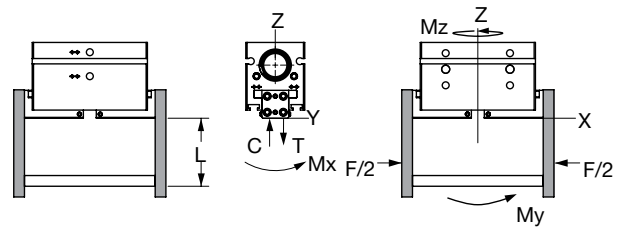

DPG-10M-2	Static	Dynamic
Maximum Tensile T	890 N [200 lbs]	111 N [25 lbs]
Maximum Compressive C	1890 N [425 lbs]	111 N [25 lbs]
Maximum Moment M_x	20 Nm [175 in-lbs]	3 Nm [25 in-lbs]
Maximum Moment M_y	23 Nm [200 in-lbs]	4 Nm [35 in-lbs]
Maximum Moment M_z	20 Nm [175 in-lbs]	3 Nm [25 in-lbs]

*Capacities are per set of jaws and are not simultaneous

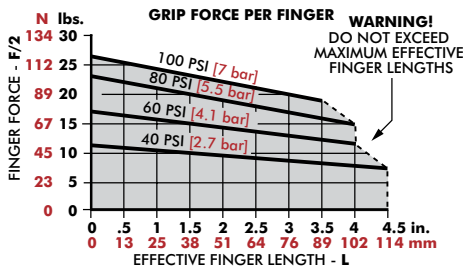

Total Additional Grip Force	Spring Open	Spring Close
@ Full Open	26 N [6 lbs]	66 N [15 lbs]
@ Full Close	102 N [23 lbs]	26 N [6 lbs]

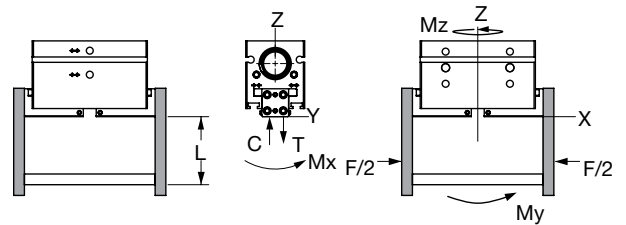

DPG-10M-3	Static	Dynamic
Maximum Tensile T	1001 N [225 lbs]	133 N [30 lbs]
Maximum Compressive C	2002 N [450 lbs]	133 N [30 lbs]
Maximum Moment M_x	23 Nm [200 in-lbs]	3 Nm [30 in-lbs]
Maximum Moment M_y	25 Nm [225 in-lbs]	5 Nm [40 in-lbs]
Maximum Moment M_z	23 Nm [200 in-lbs]	3 Nm [30 in-lbs]

*Capacities are per set of jaws and are not simultaneous

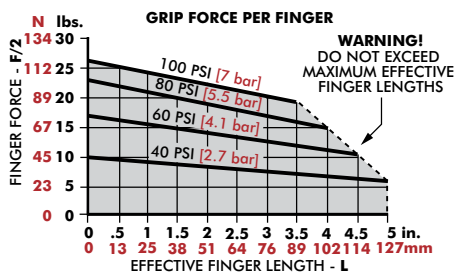

Total Additional Grip Force	Spring Open	Spring Close
@ Full Open	26 N [6 lbs]	66 N [15 lbs]
@ Full Close	97 N [22 lbs]	26 N [6 lbs]

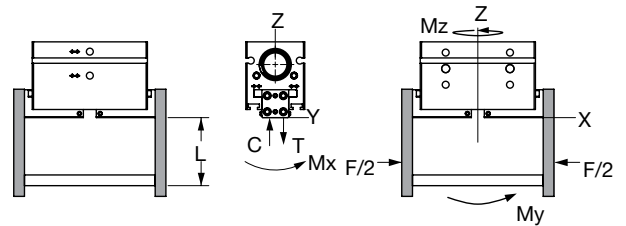

DPG-10M-4	Static	Dynamic
Maximum Tensile T	1112 N [250 lbs]	156 N [35 lbs]
Maximum Compressive C	2113 N [475 lbs]	156 N [35 lbs]
Maximum Moment M_x	25 Nm [225 in-lbs]	4 Nm [35 in-lbs]
Maximum Moment M_y	28 Nm [250 in-lbs]	5 Nm [45 in-lbs]
Maximum Moment M_z	25 Nm [225 in-lbs]	4 Nm [35 in-lbs]

*Capacities are per set of jaws and are not simultaneous